

# Conext™ XW+

## Inverter/Charger

Conext XW+ 5548 NA

Conext XW+ 6848 NA

### Owner's Guide

975-0240-01-01 Revision F  
July 2015

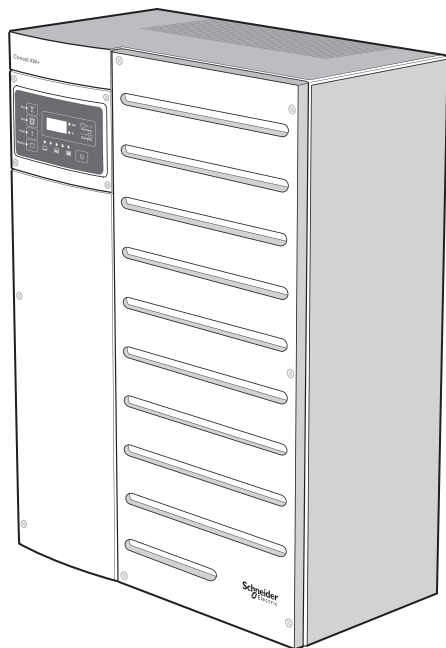



# Conext™ XW+ Inverter/Charger

Owner's Guide

Copyright © 2007-2015 Schneider Electric. All Rights Reserved.

All trademarks are owned by Schneider Electric Industries SAS or its affiliated companies.

### Exclusion for Documentation

UNLESS SPECIFICALLY AGREED TO IN WRITING, SELLER

(A) MAKES NO WARRANTY AS TO THE ACCURACY, SUFFICIENCY OR SUITABILITY OF ANY TECHNICAL OR OTHER INFORMATION PROVIDED IN ITS MANUALS OR OTHER DOCUMENTATION;

(B) ASSUMES NO RESPONSIBILITY OR LIABILITY FOR LOSSES, DAMAGES, COSTS OR EXPENSES, WHETHER SPECIAL, DIRECT, INDIRECT, CONSEQUENTIAL OR INCIDENTAL, WHICH MIGHT ARISE OUT OF THE USE OF SUCH INFORMATION. THE USE OF ANY SUCH INFORMATION WILL BE ENTIRELY AT THE USER'S RISK; AND

(C) REMINDS YOU THAT IF THIS MANUAL IS IN ANY LANGUAGE OTHER THAN ENGLISH, ALTHOUGH STEPS HAVE BEEN TAKEN TO MAINTAIN THE ACCURACY OF THE TRANSLATION, THE ACCURACY CANNOT BE GUARANTEED. APPROVED CONTENT IS CONTAINED WITH THE ENGLISH LANGUAGE VERSION WHICH IS POSTED AT [SOLAR.SCHNEIDER-ELECTRIC.COM](http://solar.schneider-electric.com).

### Date and Revision

July 2015 Revision F

### Document Part Number

975-0240-01-01

### Product Part Numbers

#### Product Part Numbers

865-6848-01 – Conext XW+ 6848 NA

865-5548-01 – Conext XW+ 5548 NA

#### Related Product Part Numbers

865-1015-01 – Conext XW+ Power Distribution Panel

865-1025 – Conext XW+ Conduit Box

865-1020-02 – Conext XW+ Connection Kit for INV2 INV3 PDP

865-1030-1 – Conext MPPT 60 150 Solar Charge Controller

865-1032 – Conext MPPT 80 600 Solar Charge Controller

865-1050-01 – Conext System Control Panel

865-1060-01 – Conext Automatic Generator Start

865-1058 – Conext ComBox

865-1080-01 – Conext Battery Monitor

### Contact Information

[solar.schneider-electric.com](http://solar.schneider-electric.com)

Please contact your local Schneider Electric Sales Representative or visit our website at:

<http://solar.schneider-electric.com/tech-support/>

### Information About Your System

As soon as you open your product, record the following information and be sure to keep your proof of purchase.

Serial Number \_\_\_\_\_

Product Number \_\_\_\_\_

Purchased From \_\_\_\_\_

Purchase Date \_\_\_\_\_

# About This Guide

## Purpose

The purpose of this Owner's Guide is to provide the information and procedures necessary for configuring, operating, maintaining, and troubleshooting the Schneider Electric Conext XW+ Inverter/Charger.

## Scope

This Guide includes information about monitoring and configuring the Conext XW+.

The Guide provides guidelines, detailed setup information, and information about operating and troubleshooting the unit. It does not provide installation procedures or details about particular brands of batteries, photoelectric cells, or generators. Consult the equipment manufacturers for this information.

## Audience

This Guide is intended for anyone who needs to operate, configure, and troubleshoot the Conext XW+ Inverter/Charger. Certain configuration tasks should only be performed by qualified personnel in consultation with your local utility and/or an authorized dealer. Electrical equipment should be installed, operated, serviced, and maintained only by qualified personnel. Keep unqualified personnel away from batteries. Servicing of batteries must only be performed or supervised by qualified personnel with knowledge of batteries and their required precautions. Qualified personnel have training, knowledge, and experience in:

- Installing electrical equipment
- Applying applicable installation codes
- Analyzing and reducing the hazards involved in performing electrical work
- Installing and configuring batteries
- Selecting and using Personal Protective Equipment (PPE)

No responsibility is assumed by Schneider Electric for any consequences arising out of the use of this material.

## Organization

This Guide is organized into four chapters and three appendices.

Chapter 1, “Introduction”, describes the operational features of the Conext XW+ Inverter/Charger.

Chapter 2, “Monitoring Operation”, contains information about monitoring Conext XW+ Inverter/Charger operation using the inverter information panel or the Conext System Control Panel.

Chapter 3, “Configuration” explains how to navigate through the Conext System Control Panel menus and configure the Conext XW+ Inverter/Charger.

Chapter 4, “Troubleshooting”, contains information and procedures for identifying and solving possible problems with the Conext XW+ Inverter/Charger.

Appendix A, “Specifications” provides the electrical and mechanical specifications for the Conext XW+ Inverter/Charger.

Appendix B contains the default configuration settings and ranges for the Conext XW+ Inverter/Charger. Configuration settings can be viewed and changed using the Conext System Control Panel.

## Abbreviations and Acronyms

CEC	California Energy Commission
CSA	Canadian Standards Association
GT	Grid Tie
LCD	Liquid Crystal Display
LED	Light Emitting Diode
MPPT	Maximum Power Point Tracking
NEC	US National Electrical Code NFPA-70
PV	Photovoltaic
PVGFP	PV Ground Fault Protection
UL	Underwriters Laboratories
VAC	Volts AC
VDC	Volts DC

## Related Information

For information about installing the Conext XW+ Inverter/Charger, see the *Conext XW+ Inverter/Charger Installation Guide* (975-0384-01-02).

You can find more information about Schneider Electric as well as its products and services at [solar.schneider-electric.com](http://solar.schneider-electric.com).

For available accessories, see “Available Conext XW+ Accessories” on page 1–3.

# Important Safety Instructions

## READ AND SAVE THESE INSTRUCTIONS - DO NOT DISCARD

This guide contains important safety instructions for the Conext XW+ Inverter/Charger that must be followed during operation and troubleshooting. **Read and keep this Owner's Guide for future reference.**

Read these instructions carefully and look at the equipment to become familiar with the device before trying to install, operate, service or maintain it. The following special messages may appear throughout this bulletin or on the equipment to warn of potential hazards or to call attention to information that clarifies or simplifies a procedure.



The addition of either symbol to a "Danger" or "Warning" safety label indicates that an electrical hazard exists which will result in personal injury if the instructions are not followed.



This is the safety alert symbol. It is used to alert you to potential personal injury hazards. Obey all safety messages that follow this symbol to avoid possible injury or death.

### **DANGER**

DANGER indicates a hazardous situation which, if not avoided, will result in death or serious injury.

### **WARNING**

WARNING indicates a hazardous situation which, if not avoided, could result in death or serious injury.

### **CAUTION**

CAUTION indicates a hazardous situation which, if not avoided, could result in minor or moderate injury.

### **NOTICE**

NOTICE is used to address practices not related to physical injury. The safety alert symbol shall not be used with this signal word.

## Safety Information

- 1. Before using the inverter, read all instructions and cautionary markings on the unit, the batteries, and all appropriate sections of this manual.**
2. Use of accessories not recommended or sold by the manufacturer may result in a risk of fire, electric shock, or injury to persons.
3. The inverter is designed to be permanently connected to your AC and DC electrical systems. The manufacturer recommends that all wiring be done by a certified technician or electrician to ensure adherence to the local and national electrical codes applicable in your jurisdiction.
4. To avoid a risk of fire and electric shock, make sure that existing wiring is in good condition and that wire is not undersized. Do not operate the inverter with damaged or substandard wiring.
5. Do not operate the inverter if it has been damaged in any way.
6. This unit does not have any user-serviceable parts. Do not disassemble the inverter except where noted for connecting wiring and cabling. See your warranty for instructions on obtaining service. Attempting to service the unit yourself may result in a risk of electrical shock or fire. Internal capacitors remain charged after all power is disconnected.
7. To reduce the risk of electrical shock, disconnect both AC and DC power from the inverter before attempting any maintenance or cleaning or working on any components connected to the inverter. Putting the unit in Standby mode will not reduce this risk.
8. The inverter must be provided with an equipment-grounding conductor connected to the AC input ground.
9. Do not expose this unit to rain, snow, or liquids of any type. This product is designed for indoor use only. Damp environments will significantly shorten the life of this product and corrosion caused by dampness will not be covered by the product warranty.
10. To reduce the chance of short-circuits, always use insulated tools when installing or working with this equipment.
11. Remove personal metal items such as rings, bracelets, necklaces, and watches when working with electrical equipment.



**⚠ DANGER****HAZARD OF ELECTRIC SHOCK, EXPLOSION, OR ARC FLASH**

- Apply appropriate personal protective equipment (PPE) and follow safe electrical work practices. See NFPA 70E or CSA Z462.
- This equipment must only be installed and serviced by qualified electrical personnel.
- Never operate energized with covers removed
- Energized from multiple sources. Before removing covers identify all sources, de-energize, lock-out, and tag-out and wait 2 minutes for circuits to discharge
- Always use a properly rated voltage sensing device to confirm all circuits are de-energized.

**Failure to follow these instructions will result in death or serious injury.**

**⚠ DANGER****HAZARD OF ELECTRIC SHOCK, EXPLOSION, OR ARC FLASH**

- Remove watches, rings, or other metal objects.
- This equipment must only be installed and serviced by qualified electrical personnel.
- Keep sparks and flames away from the batteries.
- Use tools with insulated handles.
- Wear protective glasses, gloves and boots.
- Do not lay tools or other metal parts on top of batteries.

**Failure to follow these instructions will result in death or serious injury.**

**⚠ DANGER****HAZARD OF ELECTRIC SHOCK, EXPLOSION, OR ARC FLASH**

- Battery Circuit Breakers must be installed according to the specifications and requirements defined by Schneider Electric.s.
- Servicing of batteries must only be performed by qualified personnel knowledgeable about batteries and the required precautions. Keep unqualified personnel away from batteries.
- Disconnect the charging source prior to connecting or disconnecting battery terminals.

**Failure to follow these instructions will result in death or serious injury.**

## Limitations on Use

<b>⚠ WARNING</b>
<b>LIMITATIONS ON USE</b> The Conext XW+ Inverter/Charger is not intended for use in connection with life support systems or other medical equipment or devices. <b>Failure to follow these instructions can result in death or serious injury.</b>

## Explosive Gas Precautions

<b>⚠ WARNING</b>
<b>EXPLOSION HAZARD</b> This equipment is not ignition protected. To prevent fire or explosion, do not install this product in locations that require ignition-protected equipment. This includes any space containing gasoline-powered machinery, fuel tanks, as well as joints, fittings, or other connections between components of the fuel system. <b>Failure to follow these instructions can result in death or serious injury.</b>

Working in the vicinity of lead acid batteries is dangerous. Batteries generate explosive gases during normal operation. Therefore, you must read this Guide and follow the instructions exactly before installing or using your inverter/charger.

To reduce the risk of battery explosion, follow these instructions and those published by the battery manufacturer and the manufacturer of the equipment in which the battery is installed.

## FCC Information to the User

This equipment has been tested and found to comply with the limits for a Class B digital device, pursuant to part 15 of the FCC Rules. These limits are designed to provide reasonable protection against harmful interference in a residential installation. This equipment generates, uses and can radiate radio frequency energy and, if not installed and used in accordance with the instructions, may cause harmful interference to radio communications. However, there is no guarantee that interference will not occur in a particular installation. If this equipment does cause harmful interference to radio or television reception, which can be determined by turning the equipment off and on, the user is encouraged to try to correct the interference by one or more of the following measures:

- Reorient or relocate the receiving antenna.
- Increase the separation between the equipment and the receiver.
- Connect the equipment to a circuit different from that to which the receiver is connected.
- Consult the dealer or an experienced radio/TV technician for help.



# Contents

## Important Safety Instructions

### 1 Introduction

Features	1-2
Performance Highlights	1-2
Distinguishing Features	1-2
Xanbus™ Network Communications Protocol	1-2
Available Conext XW+ Accessories	1-3
Operation	1-3
Bidirectional Theory of Operation	1-3
Surge Performance	1-7
Islanding Protection	1-7
AC Coupling	1-8
Multi-unit Operation	1-9
Auxiliary Output	1-10
Transfer Relay	1-10
K1 and K2 relay	1-10
Monitoring the Conext XW+	1-11
Conext XW+ Information Panel	1-11
Conext System Control Panel	1-12

### 2 Monitoring Operation

Monitoring Operation with the Inverter Information Panel	2-2
Monitoring AC Input Status	2-2
Monitoring Conext XW+ Status	2-3
Monitoring Charger Status	2-4
Monitoring Events	2-4
Equalizing Batteries	2-5
Using Startup/Shutdown/Standby Modes	2-6
Monitoring Battery Level	2-8
Reading the Display Screen	2-8
Monitoring Operation with the Conext SCP	2-10
Conext System Control Panel Features	2-10
Using the Standby Button	2-11
Conext System Control Panel Navigation	2-11
Viewing the Conext System Control Panel Home Screens	2-11
Viewing Other Screens	2-13
Reading the System Status Screen	2-13
Reading the Conext XW+ Home Screen	2-14
Reading the Meters Screen	2-17

### 3 Configuration

Using the Conext System Control Panel	3-2
Conext XW+ Setup Menu	3-2
Setting the Time and Date	3-3
Using the Setup Menus	3-4
Inverter Settings Menu	3-8
Using the Low Battery Cut Out and LBCO Delay Settings	3-9
Using Search Mode	3-9
Charger Settings Menu	3-11
Battery Charger Functions	3-12
Multi-Stage Charging Process	3-12
Equalize Charging	3-18
Equalization Procedure	3-19
Custom Battery Settings Menu	3-21
AC Input Settings	3-23
Grid Support Settings	3-25
Prioritizing and Managing Energy Sources with Advanced Features	3-28
Grid Support	3-28
Grid Support and Battery Charging	3-29
Charger Block	3-31
Peak Load Shaving (PLS)	3-32
Time-of-Use Metering	3-32
Self-Consumption	3-33
Generator Support Settings	3-34
Auxiliary Output Settings	3-36
Multi-Unit Config Menu	3-39
Setting the Device Name	3-41
Setting the Device Number	3-42
Three-Phase Configuration	3-43
Connections Menu	3-45
Copying Settings From Another Unit	3-47
Resetting the Conext XW+ to Default Settings	3-48
Using the Advanced Features	3-49

### 4 Troubleshooting

General Troubleshooting Guidelines	4-2
Inverter Applications	4-3
Resistive Loads	4-3
Motor Loads	4-3
Problem Loads	4-3
Very Small Loads	4-3
Fluorescent Lights and Power Supplies	4-3
Clocks	4-4
Searching	4-4

---

Inverter Troubleshooting	4-4
Battery Charger Troubleshooting	4-7
Faults and Warnings	4-10
Warning Messages	4-11
Warning Types	4-11
Fault Messages	4-16
Fault Types	4-17
Inverter Operation After Faults	4-17
<b>A Specifications</b>	
Electrical Specifications	A-2
Grid-tie Specifications	A-3
Response to Abnormal Grid Conditions	A-4
Conext XW+ Overload Capability	A-5
Output Power Versus Ambient Temperature	A-8
Conext XW+ Efficiency	A-9
Inverting Efficiency (Typical)	A-9
Charging Efficiency (Typical)	A-10
Charging Efficiency Power Factor	A-11
Mechanical Specifications	A-12
Accessories	A-13
<b>B Default Settings</b>	
Default Settings and Ranges	B-2
Inverter Settings Menu	B-3
Charger Settings Menu	B-3
Custom Settings Submenu	B-3
LithiumIon Submenu	B-4
AC Menu	B-4
Grid Support Menu	B-5
Gen Support Menu	B-5
Aux Menu	B-5
Connections Menu	B-6
Advanced Features Menu	B-6





# 1

## Introduction

Chapter 1, “Introduction”, describes the operational features of the Conext XW+ Inverter/Charger.

Topics in this chapter include:

- “Features” on page 1–2
- “Operation” on page 1–3
- “Monitoring the Conext XW+” on page 1–11

## Features

The Conext XW+ is a modular building block sine-wave inverter/charger that can be used for residential and commercial battery based off-grid, grid backup, and grid interactive applications.

The Conext XW+ is a self-contained DC to AC inverter, battery charger, and integrated AC transfer switch. It is configurable in a hybrid system to operate with generators and renewable energy sources. These configurations are capable of extending battery based off-grid/backup autonomy.

### Performance Highlights

- Excellent load starting with high 30-minute and 5-second power.
- Off-grid AC Coupling with PV inverters using frequency power curtailment method.
- Operation in hot environments up to 70°C.
- Conversion of DC energy to AC energy for export to the utility grid.
- Power factor corrected charging minimizes AC current required for charging.
- True sine wave output.

### Distinguishing Features

- Grid-interactive feature set enables time management and prioritization of energy sources and power conversion to support advanced modes of operation such as load shifting, self consumption and peak load shaving.
- Dual AC input connections with 60 A automatic transfer switch integrates both utility grid and generator.
- Generator Support functionality assists small generators with heavy loads.
- Auxiliary port assist with relay switching of external devices such as battery room fans, diversion loads and generators.
- Configurable battery parameters for customized battery charging.
- Field serviceable boards and components.

### Xanbus™ Network Communications Protocol

The Conext XW+ uses Xanbus™, a network communications protocol developed by Schneider to communicate with other Xanbus-enabled devices. You can configure and monitor the Conext XW+ and other Xanbus-enabled devices in the system using the Conext System Control Panel (part number 865-1050-01) or Conext ComBox (part number 865-1058).

## Available Conext XW+ Accessories

Accessory	Part Number
Conext XW+ Power Distribution Panel	865-1015-01
Conext XW+ Power Distribution Panel (Without AC Breakers)	865-1014-01
Conext XW+ Conduit Box	865-1025-01
Conext XW+ Connection Kit for INV2 INV3 PDP	865-1020-02
Conext System Control Panel	865-1050-01
Conext Automatic Generator Start	865-1060-01
Conext MPPT 60 150 Solar Charge Controller	865-1030-1
Conext MPPT 80 600 Solar Charge Controller	865-1032
Conext ComBox	865-1058
Conext Battery Monitor	865-1080-01
Conext XW+ PDP 120/240V 60A Breaker Kit	865-1215-01
Conext XW+ PDP 3-Phase 60A Breaker Kit	865-1315-01

## Operation

### Bidirectional Theory of Operation

The Conext XW+ is a grid forming device consisting of a bidirectional inverter/charger. It is capable of inverting DC power into AC power and controlling the voltage and frequency of its inverter output. It will power external loads attached to AC OUT (See Figure 1-2, “Inverting of DC to AC Connected to AC OUT” on page 1-4).

The Conext XW+ is also capable of charging external batteries by converting AC power into DC power (See Figure 1-3, “Charging External Batteries and Supplying AC Out with AC Pass-through from AC1 Grid ” on page 1-5). The Conext XW+ accepts AC power through connection AC2 for charging batteries, usually from a generator (See Figure 1-4, “Charging External Batteries and Supplying AC Out with AC Pass-through from AC2 Generator” on page 1-5).

The Conext XW+ will convert externally sourced DC power into AC power for export to the utility grid attached to its AC1 connection (See Figure 1-5, “Converting Excess Available DC power for Export to Utility Grid (AC1) and AC Out” on page 1-6).

The Conext XW+ has an internal automatic transfer switch (K1, K2) which allows either AC1 or AC2 to be connected to the inverter input, but not both at the same time (See Figure 1-1, "Connection Points and Major Power Conversion Components of Conext XW+ " on page 1–4). This allows shared AC energy during charging or to directly pass through from AC1, or AC2, to AC Out.

Through firmware control over power conversion and the management of K1 and K2, Conext XW+ can facilitate advanced interaction with the utility grid to optimize the utilization of renewable and non-renewable energy sources. Because the Conext XW+ is a device capable of forming an AC grid signal (AC voltage and frequency) it is also ideal for use off-grid.

The red arrows in the diagrams below represent the direction of power flow in the respective modes of operation. These modes and other special functions will be explained throughout this manual.

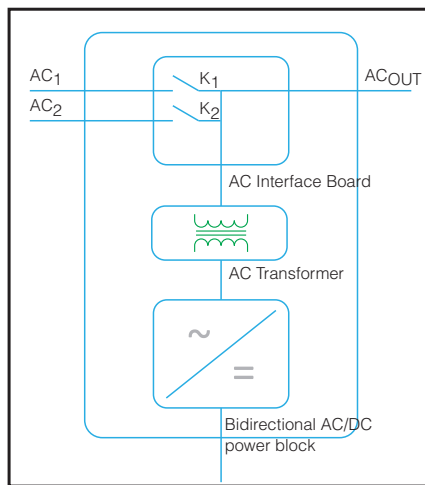

**Figure 1-1** Connection Points and Major Power Conversion Components of Conext XW+

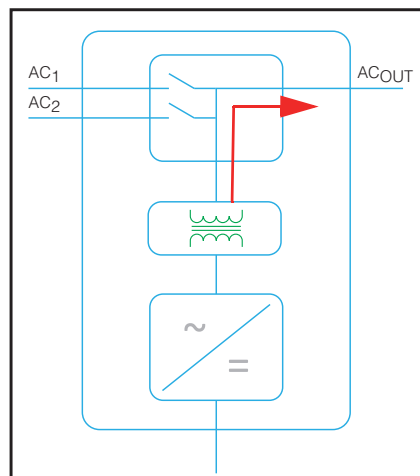

**Figure 1-2** Inverting of DC to AC Connected to AC OUT

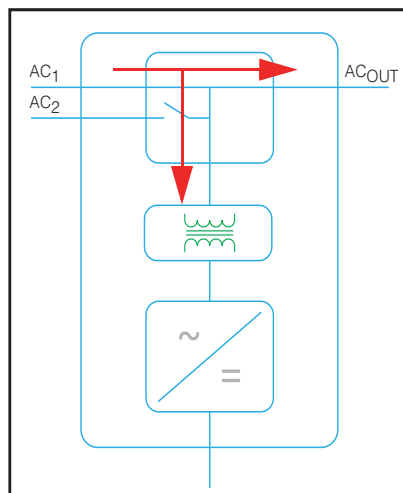

**Figure 1-3** Charging External Batteries and Supplying AC Out with AC Pass-through from AC1 Grid

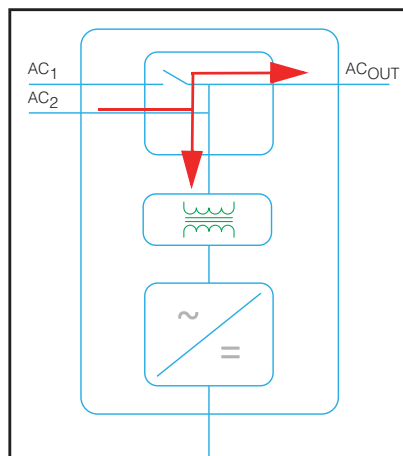

**Figure 1-4** Charging External Batteries and Supplying AC Out with AC Pass-through from AC2 Generator

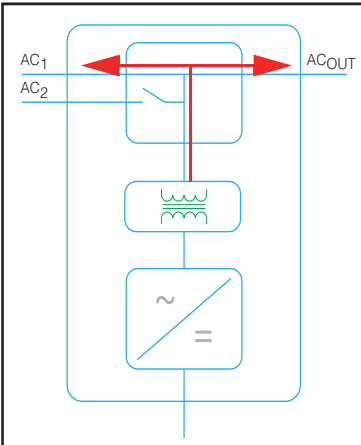

**Figure 1-5** Converting Excess Available DC power for Export to Utility Grid (AC1) and AC Out

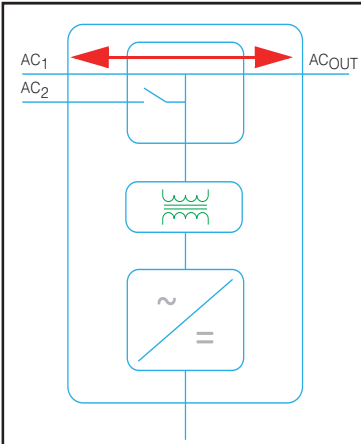

**Figure 1-6** AC Pass-through

---

## Surge Performance

Unlike many other inverters, the Conext XW+ helps stop voltage from sagging dramatically during surge conditions. The Conext XW+ handles surges of over twice its rated output power with only a minimal drop in output voltage for limited periods of time.

## Islanding Protection

Islanding protection is an essential safety feature that helps reduce harm to those working on the utility grid from a distributed energy source such as the Conext XW+. Islanding protection also helps to prevent loads connected to the Conext XW+ from being damaged by a fluctuating utility grid input. The Conext XW+ uses proprietary positive feedback control to achieve anti-islanding operation while maintaining low total harmonic distortion at the grid connection. Default software settings are programmed into each Conext XW+ at the factory so that they comply with applicable safety regulations (such as IEEE 1547 and UL 1741 in North America).

In some instances it may be desirable from both a utility and a customer point of view to adjust the default anti-islanding settings. For example, the Conext XW+ may experience “nuisance trips” if the grid is weak and the voltage falls outside the allowable range specified by regulations. It may be difficult for a utility to adjust the grid to stop this problem. With permission from the utility, the factory settings may be changed to allow the Conext XW+ to operate over a wider grid voltage range. These settings must only be changed by qualified service personnel using a special software application (Conext Configuration Tool, Order # 865-1155-01) provided by the manufacturer.

While exporting energy, the Conext XW+ continuously monitors the utility grid voltage and frequency. If the grid voltage or frequency move beyond the Conext XW+ default ranges (for example, during a power surge or outage) the Conext XW+ stops exporting energy through AC1 and disconnects from the utility. If disconnected due to a grid voltage disturbance, five minutes is the non-adjustable minimum reconnect time during which the Conext XW+ does not export energy through AC1 to the grid. The Fault light on the Conext XW+ information panel will indicate a utility fault. No fault code appears on the three-character display because the fault is with the utility grid, not with the Conext XW+.

In addition to the information panel, the Conext System Control Panel indicates a utility fault with the Fault light and also displays a fault message on screen (faults F23 to F40 are utility faults—see Figure 4-6, “Fault Messages” on page 4-19). The fault cannot be manually cleared. Utility faults will clear automatically when the utility grid voltage and frequency return to within the ranges programmed into the Conext XW+. If grid support is enabled and the utility voltage and frequency come back within tolerance, the Conext XW+ information panel displays a countdown timer for five minutes until the Conext XW+ can start interacting with the grid again.

## AC Coupling

Off-grid AC Coupled system architecture is often used to create a stand-alone grid. Commonly this means that PV inverters are connected to the output of a battery-based inverter/charger putting both on the same AC bus along with the AC loads. In this scenario, the battery powered inverter charger provides the necessary frequency and voltage to enable the PV inverter to produce power. This type of system must be able to maintain power generation in balance with power consumption at all times. If there is more power being generated than can be consumed by the loads, power will flow to the inverter/charger and be converted to DC power which flows into the battery. Once the battery reaches capacity, power generation by the PV inverter must be curtailed to maintain the balance between generation and consumption. As the battery bank reaches capacity, Conext XW+ curtails PV inverter generation by raising the AC line frequency causing compatible PV inverters to reduce their power output in an orderly manner. This is called Active Frequency Shift Power Curtailment.

During a grid outage even a home with a grid-tie PV inverter system will be without power because PV inverters cannot produce power without the presence of a reference voltage and frequency. To enable the PV inverter to provide power during a grid outage the Conext XW+ is retrofitted in front of the PV inverter. The PV inverter is rewired from the grid connection to a critical load (sub) panel and the AC Couple is on the Conext XW+ AC Output port. When the grid is present, PV inverter power feeds the loads and any excess is exported by Conext XW+ to the grid using AC1 (where permitted by the local utility). During a grid outage, Conext XW+ anti-islanding protection prevents power from being exported to grid on AC1. Conext XW+ then uses Active Frequency Shift Power Curtailment to reduce the power output of compatible PV inverters, maintaining the balance of generation and consumption.

Consult the manufacturer's specifications to determine if your PV inverter is compatible with Active Frequency Shift Power Curtailment. Conext XW+ AC coupling function is enabled by default (Advanced Features Menu).

<b>NOTICE</b>
<b>AC COUPLED PV INVERTER COMPATIBILITY</b>
AC power generated by AC coupling PV inverters with Conext XW+ must be consumed by AC loads or used to charge batteries. As an alternative, the excess power produced from a PV inverter can be routed to dump loads. Do not AC couple PV inverters with the Conext XW+ that are unable to reduce, derate or cease the excess PV inverter power in response to the changes in AC line frequency controlled by the Conext XW+. Consult the manufacturer's specifications of your PV inverter and confirm compatibility.
<b>Failure to follow these instructions can result in equipment damage.</b>

The AC coupling advanced setting should remain enabled except in cases when the DC voltage level is allowed to have large variations and the line frequency needs to remain constant.



---

Further details about AC Coupling can be found in the document *AC Coupling of Inverters Solutions Guide* (975-0240-01-01) available at [solar.schneider-electric.com](http://solar.schneider-electric.com).

## Multi-unit Operation

Up to three Conext XW+ units can be installed together in a single phase configuration with the Conext PDP (Power Distribution Panel). A maximum of four Conext XW+ units can be installed together in a single phase configuration with the addition of a second PDP. The PDP is an ideal optional companion for managing AC connections and integrating a battery bank and other DC connections. Regardless of how it is installed, the maximum number of Conext XW+ in a single phase or split phase configuration is four.

Three Conext XW+ units can also be configured in a cluster for three-phase operation using a single PDP (PDP is optional). Up to four clusters of three Conext XW+ units can be installed in a three-phase configuration when using an external AC contactor.

Multiple Conext XW+ units and other Xanbus devices with common connections to battery banks, PV arrays, the utility grid or a generator require programming during commissioning to enable correct operation.

### Inverting

For multiple units, the master Conext XW+ synchronizes operation of other connected units using the same Xanbus network. When AC loads are present, all units produce power, effectively sharing the load. Multiple units do not produce power together when Search mode is enabled. See “Using Search Mode” on page 3–9.

### Parallel Charging

Multiple Conext XW+ units on the same Xanbus network synchronize their charging stages to help provide efficient charging of the battery bank. When a single unit transitions from bulk to absorption, so do all other units. In absorption, all units must complete the absorption stage before any of them transition to the next stage. Note that units stop sharing charge current just before completing the bulk stage and only share charging load during the bulk stage.

Each Conext XW+ unit provides a maximum charging current set by the Max Charge Rate setting. The maximum current may be decreased, subject to the internal operating temperature.

When one or more Conext Solar Charge Controllers are installed and operating in the system, Conext XW+ units synchronize only their bulk charging stage with the charge controllers.

---

**Note:** Equalization is device specific. Only the device(s) on which equalization was initiated will perform the equalization. Other devices will stay in float or no-float depending on their settings.

---

### **AC Transfer**

Multiple Conext XW+ units monitor each other to determine the quality of AC input. If AC input is deemed to be bad by any of the paralleled units, no transfer to AC Out occurs and the AC LED continues to flash on each unit's information panel until the AC is qualified by all. If the system was in pass-through and AC fails on any unit, all units transfer to invert simultaneously.

### **Faults**

When the Conext XW+ detects a fault condition, the fault is displayed on the Conext XW+. The Conext XW+ also turns on the Fault light on the Conext XW+ and inverter information panel. A fault affects the operation of the unit. See "Fault Types" on page 4-14 for an explanation of the different fault types.

- When a single Conext XW+ slave unit in a multi-unit system has a fault, only the affected device shuts down.
- When a master unit has an invert mode fault that causes it to stop inverting, it is considered a system-wide fault and all units shut down. Invert mode faults on slave units only shut down the affected slave unit.
- All units shut down when there is a battery-related fault such as battery over-temperature or over-voltage.

**Independent Operation of Features** Each Conext XW+ grid-interactive feature (e.g. enhanced grid support, grid sell, load shave and generator support) operates independently. This enables Conext XW+ units in a multi-unit system to be configured to perform multiple functions independently and allows greater flexibility in operating the entire system.

## **Auxiliary Output**

Each Conext XW+ has one programmable 12 V, 0.25 A auxiliary output that is able to run a small fan or operate an external relay to perform other functions. Examples include remotely starting a two-wire start generator in cases where the Xanbus-enabled Conext AGS is not used, disconnecting external non-critical loads, or turning on a diversion load for battery voltage regulation. See "Auxiliary Output Settings" on page 3-36 for programme parameters.

## **Transfer Relay**

The built-in transfer relay is rated for 60 amps. When an external AC source is detected and qualified on either of the AC1 or AC2 inputs, the relay transfers loads from the Conext XW+ to the external power source, and then activates the battery charger. Multi-unit systems of three or more require the use of an external AC contactor to manage the AC bus.

## **K1 and K2 relay**

The Conext XW+ design does not allow the K1 and K2 relays to close simultaneously. This design helps stop the generator input (AC2) from back feeding to the utility grid (AC1).

## Monitoring the Conext XW+

Operation of the Conext XW+ can be monitored using the factory-installed inverter information panel or the optional Conext System Control Panel and ComBox. To configure the Conext XW+, the Conext System Control Panel or ComBox must be used.

### Conext XW+ Information Panel

The Conext XW+ information panel features:

- Buttons for Conext XW+ Startup/Shutdown/Standby control, clearing faults and warnings, and battery equalization.
- A three-character display to indicate power output, charge current, anti-islanding countdown or troubleshooting information.
- LEDs to indicate AC input status, output status, battery condition, and system warnings/faults.

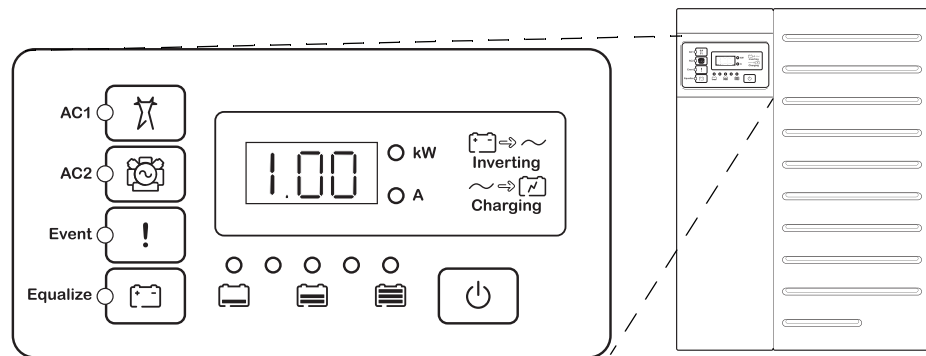

**Figure 1-7** Conext XW+ Information Panel

## Conext System Control Panel

The Conext System Control Panel (Conext SCP) or Conext ComBox is required for configuring the Conext XW+ and other Xanbus-enabled system components.

The Conext SCP features:

- A liquid crystal display which provides graphics and text describing real time operation and status information.
- LED event and warning indicator.
- Internal clock which is used to control time-dependent Conext XW+ functions.
- Buttons to select configuration menus, customize Conext XW+ functions and clear faults and warnings.

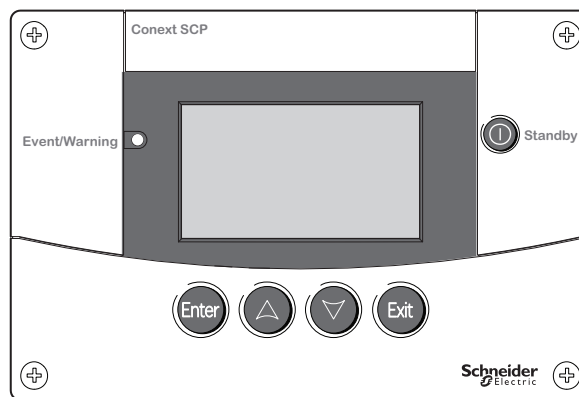

**Figure 1-8** Conext System Control Panel

# 2

## Monitoring Operation

Chapter 2, “Monitoring Operation”, contains information about monitoring Conext XW+ Inverter/Charger operation using the inverter information panel or the Conext System Control Panel.

The topics in this chapter include:

- “Monitoring Operation with the Inverter Information Panel” on page 2–2
- “Monitoring Operation with the Conext SCP” on page 2–10

## Monitoring Operation with the Inverter Information Panel

The inverter information panel on each Conext XW+ monitors a single Conext XW+. The Conext XW+ information panel displays basic information and performs start up, shut down, equalization and standby functions. LEDs on the information panel indicate AC input status, Conext XW+ status, battery condition, and charging and equalization status. The Conext XW+ LEDs and three-character display screen indicate warning and event conditions.

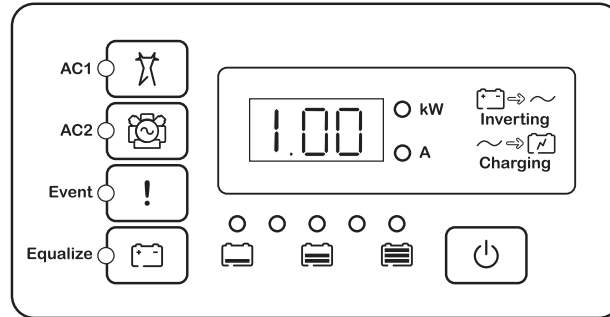

Figure 2-1 Inverter Information Panel

### Monitoring AC Input Status

**Grid (AC1)** The green Grid (AC1) LED indicates the presence and status of the AC source connected to the AC1 input.

Symbol	LED On	LED Flashing	LED Off
	AC input is present and qualified. The Conext XW+ is ready to charge batteries, pass AC through to the loads, or interact with the grid.	AC input is present and is being qualified.	The Conext XW+ is not connected to the grid. AC input is not present, or AC input is present but not within qualifying range.

**Gen (AC2)** The green Gen (AC2) LED indicates the presence and status of a generator or other auxiliary AC source on the AC2 input.

Symbol	LED On	LED Flashing	LED Off
	The AC source is present and AC input is qualified. The Conext XW+ is ready to charge batteries and pass power through to the loads.	AC input is present and is being qualified.	AC input is not present, or AC input is present but not within qualifying range.

When one AC input LED is on and the other AC input LED is flashing, AC input is present on both AC1 and AC2. However, the Conext XW+ can qualify and receive AC input from only one source at a time. The qualified source is represented by the steadily lit LED. When two sources of AC input are present, the Conext XW+ uses the source selected under **AC Priority** in the **AC Settings** menu.

## Monitoring Conext XW+ Status

The Green kW LED indicates the Conext XW+ is inverting DC input to AC output. When this LED is on or flashing, the display screen shows Conext XW+ output power in kilowatts.

Symbol	LED On	LED Flashing	LED Off
○ kW	The Conext XW+ is inverting and generating an AC output. Display screen shows output power in kW.	The Conext XW+ is in Grid Support mode. Display screen shows output power in kW.	The Conext XW+ is not inverting.

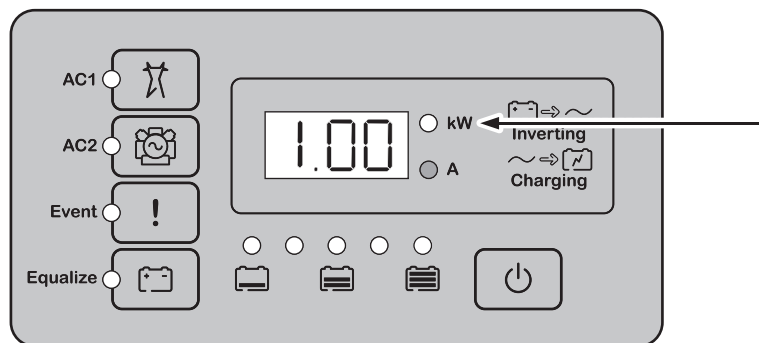

Figure 2-2 Inverter Information Panel When Inverting

## Monitoring Charger Status

The green LED labelled “A” indicates the Conext XW+ is charging the battery bank. When this LED is on, the numeric display screen shows battery charging current in amps.

Symbol	LED On	LED Flashing	LED Off
○ A	The Conext XW+ is charging the battery bank. The numeric display screen shows battery charging current in amps.	AC coupled charging is occurring <sup>a</sup> .  May flash in AC coupled mode where reverse current greater than 3 A is present.  Multiple units are connected in parallel under no load.	The Conext XW+ is not in charge mode.

a. See the document “AC Coupling of Inverters Solutions Guide” available at [solar.schneider-electric.com](http://solar.schneider-electric.com) for more information about AC coupling.

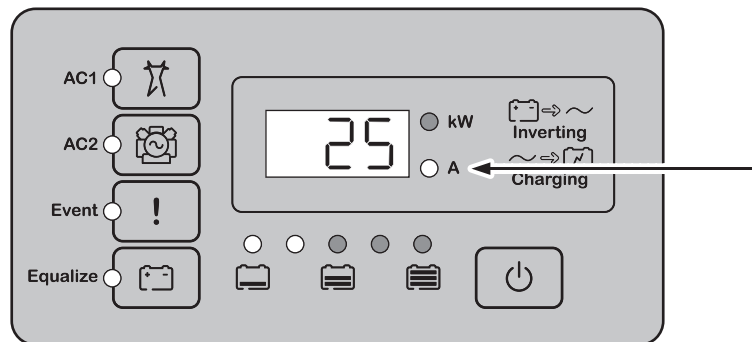

**Figure 2-3** Inverter Information Panel When Charging Battery

**Note:** When a charge cycle ends or charging is manually disabled, the Conext XW+ does not leave charge mode immediately, and the charging LED remains on for 60 seconds.

## Monitoring Events

The Red Event LED indicates the presence of a fault or warning in the system. To clear active events, briefly press and release the STARTUP/SHUTDOWN button.



Symbol	LED On	LED Flashing
	The Conext XW+ has a fault and has stopped charging or inverting. The LED also turns on steadily if the unit has both a fault and a warning.	The Conext XW+ has a warning. A warning may escalate to a fault if the warning condition does not go away.

## Equalizing Batteries

### Button

Pressing the Equalize button (  symbol) for five seconds initiates a battery equalization cycle. This cycle is used to restore battery capacity when battery life has deteriorated due to sulphation. After the button is pressed the Conext XW+ begins a full charge cycle, which is automatically followed by an equalization cycle. Equalization functions only when AC is present and qualified and the charger is enabled. Otherwise the Conext XW+ generates a **Cannot Equalize** warning (W96).

### WARNING

#### EQUALIZATION HAZARD

Only flooded lead acid batteries should be equalize charged. Hydrogen and oxygen gases are produced when batteries are equalized and can potentially cause an explosion if ignited. Corrosive battery acid can escape.

Provide adequate ventilation and remove all sources of ignition, such as open flames, sparks, electric motors, relays, light switches, etc.

Equalization voltage is significantly higher than nominal battery voltage. Detach electronics that can be damaged by high DC voltage.

**Failure to follow these instructions can result in death or serious injury.**

**⚠ WARNING**

**BATTERY TYPE AND SETUP HAZARDS**

Incorrect battery configurations or settings for battery types can lead to dangerously high battery temperature, fire and explosion. To avoid damaging your batteries during charging or equalization, and to minimize the risk of fire or explosion consult battery manufacturer's documentation before setting battery parameters and follow the battery manufacturer's recommended settings.

- Always use and connect the Battery Temperature Sensor (BTS).
- Always verify that the configured battery type matches the battery type being used.
- Custom battery settings should be configured by qualified personnel only.
- When using Lithium-Ion batteries, ensure that the battery pack being used includes a Battery Management System (BMS) with safety controls.

**Failure to follow these instructions can result in death or serious injury.**

Further details about Lithium Ion support can be found in the document *“Lithium Ion Application Note (Document Number: 976-0319-01-01)”* available at [solar.schneider-electric.com](http://solar.schneider-electric.com).

**Note:** In a system where more than one device is capable of equalizing batteries (such as a system including multiple Conext XW+ units and/or Conext Solar Charge Controllers), there is no system-wide equalization command for all devices. To equalize with multiple devices, each would have to be enabled individually. Alternatively, equalization can be performed using only the selected device. During the equalization process, one device applies the equalization charge while the other devices continue to operate in synchronized charge mode, typically in float (three-stage charging) or no-float (two-stage charging).

For more information, see “Equalize Charging” on page 3–18.

**LED**

The yellow Equalize LED indicates that the Conext XW+ is equalizing batteries.

Symbol	LED On	LED Flashing
	The Conext XW+ has begun equalizing the batteries.	Equalization has been requested but has not begun. The Conext XW+ must complete a charge cycle before applying the equalization charge.

## Using Startup/Shutdown/Standby Modes

### Startup/Shutdown control

When the Conext XW+ is operating, pressing and holding the STARTUP/SHUTDOWN button for five seconds shuts down the unit. To return the unit to its previous operating state, press the STARTUP/SHUTDOWN button again.

While the Conext XW+ is turning off, the other inverter information panel buttons stop working. The shutdown process cannot be cancelled. The Conext XW+ can only be restarted once the display is blank.

### Standby mode

In Standby mode, the Conext XW+ stops charging, inverting, and allowing AC to pass through to the AC output. However, the unit remains powered and present on the Xanbus network.

To put the Conext XW+ into Standby mode, press and hold the STARTUP/SHUTDOWN button and the Equalize button simultaneously for about five seconds. The display shows 5**±**b. To return the Conext XW+ to operating mode, press the STARTUP/SHUTDOWN button momentarily.

Pressing the STARTUP/SHUTDOWN button momentarily while the Conext XW+ is operating clears active faults and warnings.

### Single-unit installations

In a single-unit installation, when the Conext XW+ is shut down using the STARTUP/SHUTDOWN button, Xanbus network power is off. When Xanbus network power is off, network-connected accessories such as the Automatic Generator Start (Conext AGS) and Conext SCP could lose power and stop operating. Conext Solar Charge Controllers continue to operate if Xanbus network power is removed, but they do not continue to communicate with each other. Furthermore, the Conext Combox will not collect harvest data while it is off, even though MPPT is still functioning and collecting data.

If the STARTUP/SHUTDOWN button is pressed and held on a Conext XW+ and a Conext AGS is installed in the system, the unit stops inverting or charging immediately and shuts down completely in 120 seconds. During this time, the display shows **OFF**. This interval allows the Conext AGS to stop the generator after a cool down period. During the 120 second shutdown time, all network communication is blocked and the unit sends a shutdown command to all other devices in the system. As well, the inverter information panel buttons stop working. The shutdown process cannot be cancelled. The Conext XW+ can only be restarted again once the display is blank.

### Multiple-unit installations

If the STARTUP/SHUTDOWN power button is pressed and held on a master Conext XW+ (see “Inverter Mode” on the “Multi-Unit Config Menu” on page 3–39) and a Conext AGS is installed in the system, the unit stops inverting or charging immediately and turns off completely in 120 seconds. During this time, the display shows **OFF**. This interval allows the Conext AGS to stop the generator after a cool down period. During the 120 second shutdown time, the master unit stops network communication and the slave units issue an external sync fault (F69) or a system configuration fault (F66). As well, the inverter information panel buttons stop working. The shutdown process cannot be cancelled. The Conext XW+ can only be restarted once the display is blank.

In a multiple-unit installation, when a slave Conext XW+ is shut down, other Conext XW+ units continue to supply Xanbus network power and the Conext AGS and Conext SCP continue to operate.

## Monitoring Battery Level

When the Conext XW+ is inverting, the row of five LEDs indicates the approximate available SOC (State of Charge) of the batteries connected to the system. This capacity reading is based on battery voltage.

The battery LEDs can retrieve information from various sources depending on the devices installed in the system. SOC information is reported from one of the following devices, listed in order of priority:

1. Conext Battery Monitor (If installed).
2. Conext MPPT Solar Charge Controller (When operating).
3. Conext XW+.

When the Conext XW+ is reporting, there are four battery states from empty to full. When the available battery state is empty, no LEDs are lit. The battery is considered empty when its depth of discharge exceeds approximately 50 per cent. When the battery capacity is low, the two leftmost LEDs are lit. When the battery is at medium capacity, the four leftmost LEDs are lit. When the battery capacity is full, all five LEDs are lit. When the Conext Battery Monitor or Conext MPPT Solar Charge Controller devices are reporting, the true SOC will be indicated on the battery level LEDs and all LEDs will be utilized.

---

**Note:** The battery LEDs are not a precise indicator of battery level. They are to be considered a general guideline rather than an exact measurement. For greatest accuracy, install the Conext Battery Monitor (Part # 865-1080-01).

---

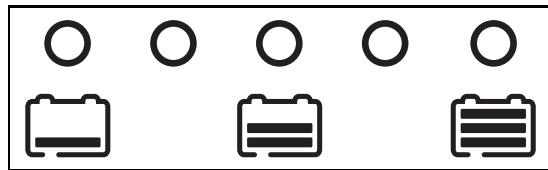



Figure 2-3 Battery Level LEDs

## Reading the Display Screen

The numeric display screen shows the following information about the operational state of the Conext XW+:

- Output power in kilowatts (when the   $\Rightarrow$   $\sim$  (kW) LED is lit).
- Battery charger current in Amps (when the  $\sim \Rightarrow$   (A) charging LED is lit).
- $5\pm b$  when the Conext XW+ is in Standby mode.

- $Sch$  when the Conext XW+ is in Search mode. See “Using Search Mode” on page 3–9.
- $\square FF$  when the STARTUP/SHUTDOWN button is pressed and held for five seconds.  $\square FF$  is displayed briefly before the unit turns off.
- “---” appears when the Conext XW+ is in transition between modes, when inverter selection is disabled via the SCP or Conext Combox, or operating in AC pass through mode (for example, in a multi-cluster configuration).
- $En$  appears momentarily when the Conext XW+ is enabled.
- $dI 5$  appears momentarily when the Conext XW+ is disabled.
- 5 minute countdown timer value may appear if there is no other more significant information to display after grid interruption during energy export operation.

## Monitoring Operation with the Conext SCP

The Conext System Control Panel (Conext SCP) provides remote configuration and monitoring capability for the Conext XW+ and all other Xanbus-enabled devices in the network.

You can monitor Conext XW+ operation on the Conext SCP using the:

- System Status screen (see page 2–13)
- Conext XW+ Home screen (see page 2–14)
- Conext XW+ Meters Menu (see page 2–17).

### Conext System Control Panel Features

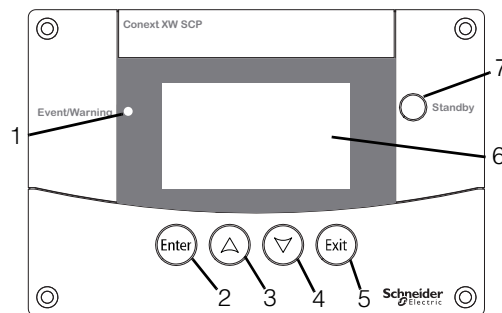

Feature	Description
1	<b>Event/Warning light</b> indicates a device on the system has a fault or warning condition and requires attention. The light flashes when a warning occurs and turns on steadily when a fault occurs.
2	<b>Enter button</b> confirms selection of a menu item or displays the next screen.
3	<b>Up arrow button</b> scrolls upwards through screen text or increases a selected value.
4	<b>Down arrow button</b> scrolls downwards through screen text or decreases a selected value.
5	<b>Exit button</b> cancels selection of a menu item or displays the previous screen.
6	<b>Display</b> shows menus, settings, and system information.
7	<b>Standby button</b> disables inverting and charging on all Conext XW+ units in the system when pressed for one to two seconds. To enable inverting and charging, press the Standby button again.

## Using the Standby Button

The Standby button has two functions. The Standby button can disable inverting and charging for the Conext XW+ units in the system or when pressed simultaneously with the Exit button, can put the entire system into Standby mode.

Pressing the Standby button produces the same result as disabling **Invert** and **AC Charge** in the System Settings menu. Pressing the Standby button momentarily affects only Conext XW+ units; it does not affect Conext Solar Charge Controller operation. After disabling inverting and charging with the Standby button, the system continues to pass AC power through to the loads, and “---” is displayed on the inverter information panel.

Pressing the Exit and Standby buttons at the same time puts the entire Conext power system (including Conext Solar Charge Controllers) into Standby mode. In Standby mode, the Conext XW+ units stop passing AC power through to the loads, and **Stb** is displayed on inverter information panel.

If a Conext AGS is installed and a generator is running, the system commands the generator through a cool down and shut down cycle. This operation cannot be interrupted and may take up to 120 seconds.

## Conext System Control Panel Navigation

This section describes the different types of screens and menus on the Conext SCP that are useful for monitoring or controlling Conext XW+ operation.

### Viewing the Conext System Control Panel Home Screens

The top level screens on the Conext SCP are the startup screen, the **System Status** screen and the device **Home** screen. Whenever power is applied the startup screen appears, followed by the **System Status** screen. Press the up or down key to view the device **Home** screen for any system connected Xanbus devices. See Figure 2-4.

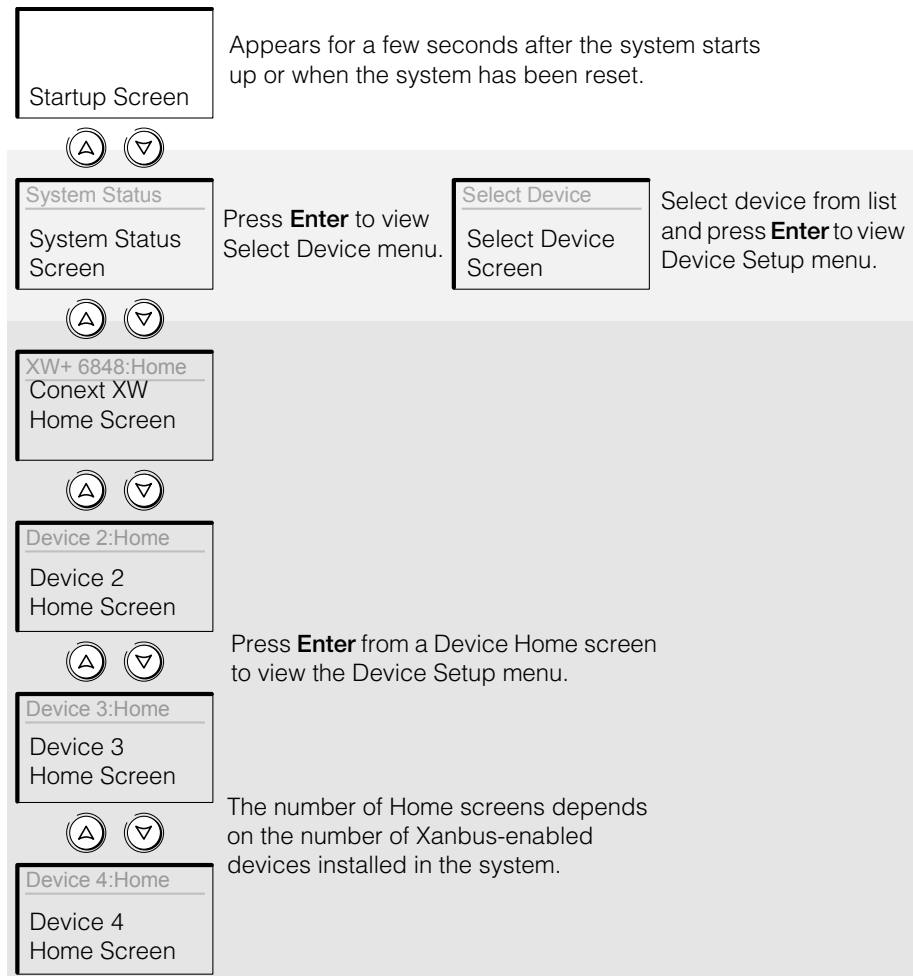

**Figure 2-4** Conext System Control Panel Top Level Screens

**System Status Screen** The **System Status** screen appears after the startup screen. It displays aggregated status information for the entire power system. For example, a system might have three Xanbus network-connected Conext XW+ Inverter/Chargers, two Conext Solar Charge Controllers, one Conext AGS module, and one Conext SCP connected to a single battery bank, a single generator, and a common utility grid.

The **System Status** screen features a **Menu** arrow pointing to the Enter button. Pressing **Enter** takes you to the **Select Device** menu. For more information, see “Reading the System Status Screen” on page 2–13.

**Note:** If you are uncertain as to which Conext SCP screen or menu you are viewing, you can return to the starting point—the **System Status** screen—by pressing **Exit** repeatedly until the screens stop changing.

**Conext XW+ Home Screen** The Conext XW+ **Home** screen is the first of the device **Home** screens. Each Conext XW+ installed in the system has its own **Home** screen.



The Conext XW+ **Home** screen displays status information for the Conext XW+. The screen appearance varies with the status of the Conext XW+ (standby, inverting, etc.) For more information, see “Reading the Conext XW+ Home Screen” on page 2–14.

**To display the Conext XW+ Home screen:**

- While viewing the **System Status** screen, press the down arrow key.

## Viewing Other Screens

This section describes the next level of screens and menus on the Conext SCP.

**Select Device Menu** The **Select Device** menu displays a list of Xanbus-enabled devices in the system, including the Conext XW+ and the Conext SCP. From this menu you can access the **Setup** menus for each device in the system.

The **Select Device** menu also contains the **Clock** menu (where the time and date are set) and the **System Settings** menu (where system-level settings can be configured). These menus and the Conext SCP menu are available from the **Select Device** menu, regardless of the number of Xanbus-enabled devices installed.

**To display the Select Device menu:**

- While viewing the **System Status** screen, press **Enter**.

**Device Setup Menus** **Device Setup** menus display status information (on the **Meters** screen) and changeable settings. Changeable settings are identified by the square brackets [ ] around values in the right-hand column.

**To display the Setup menu for a device:**

- Highlight the device name on the **Select Device** menu and press **Enter**. Alternatively, from the device **Home** screen, press **Enter**.

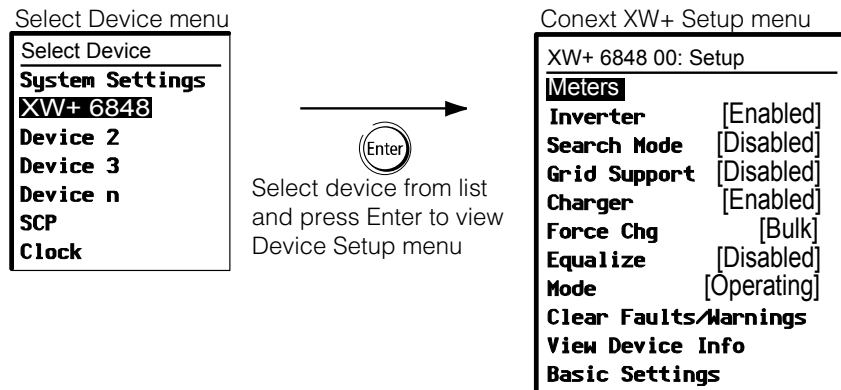

Figure 2-5 Selecting a Device Setup Menu

## Reading the System Status Screen

The **System Status** screen displays:

- Qualified AC source (if applicable) and total power to and from the source.
- Battery voltage and capacity level.
- Net battery input or output current.
- Total inverter loading.
- Time and date.

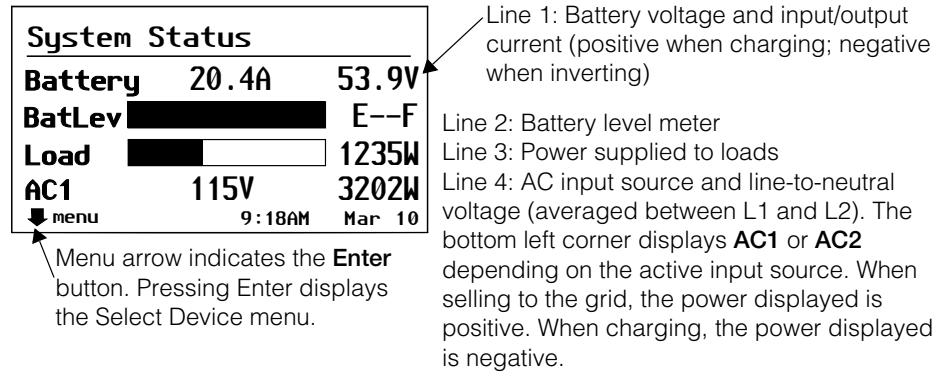

Figure 2-6 System Status Screen

## Reading the Conext XW+ Home Screen

The Conext XW+ **Home** screen displays real-time operational data specific to the Conext XW+. The Conext XW+ status changes according to the states described in Table 2-1 on page 2-15.

### To view the Conext XW+ Home screen:

- On the system **Home** screen, press the down arrow button until the Conext XW+ **Home** screen appears.

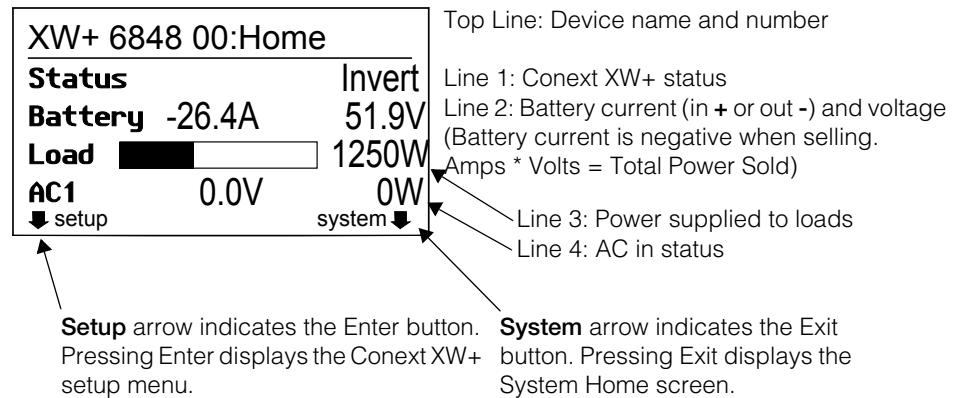

**Figure 2-7** Conext XW+ Home Screen

Press the down arrow button from the Conext XW+ **Home** screen to display the **Home** screens for other units and other Xanbus-enabled devices in the system.

**Table 2-1** Conext XW+ Home Screen States

Conext XW+ Status	Displayed When...
Invert	The Conext XW+ is supplying power to loads on AC OUT by inverting power from the batteries. AC input from the utility (AC1) or generator (AC2) is absent or out of nominal range.
Qualifying AC	The Conext XW+ is determining if AC input on AC1 or AC2 is within a usable voltage and frequency range. <b>Qualifying AC</b> is also displayed when the Conext XW+ is awaiting application of AC power or a command to enable invert mode.
Charging	The Conext XW+ is charging the batteries from qualified AC input from the utility grid (AC1) or a generator (AC2). The charge state is in transition to either bulk, absorption, float, or equalize. AC input is also passed through to the load while charging.
Bulk	The Conext XW+ is bulk charging the batteries from qualified AC input from the utility grid (AC1) or a generator (AC2). AC input is also passed through to the load while bulk charging.
Absorption	The Conext XW+ is absorption charging the batteries from qualified AC input from the utility grid (AC1) or a generator (AC2). AC input is also passed through to the load while absorption charging.
ABS Finish	The Conext XW+ has completed the absorption stage and is waiting for other Conext XW+ units in the system to complete absorption. This status can occur only when there is another Conext XW+ also charging the battery.
Float	The Conext XW+ is float charging the batteries from qualified AC input from the utility grid (AC1) or a generator (AC2). The Conext XW+ is set for three-stage charging. AC input is also passed through to the load while float charging.

**Table 2-1** Conext XW+ Home Screen States

<b>Conext XW+ Status</b>	<b>Displayed When...</b>
CHG Finish	The Conext XW+ has completed charging or the charge cycle has been interrupted and is transitioning to the next state. This stage lasts about one minute, while the battery is allowed to settle and battery voltage to drop back to normal. The delay keeps the Conext XW+ from unnecessarily transitioning to grid support (if enabled) due to the high battery voltage after a charge cycle.
Fault	The Conext XW+ has an active fault. The Event light on the Conext SCP is on.
Gen Support	<p>There is AC input from the generator on AC2, and the Conext XW+ is supporting the generator by supplying additional power to the loads attached to AC Out.</p> <p>The Conext XW+ supports the generator (or other power source connected to the generator [default AC2] input) when the AC load current drawn from the generator exceeds the <b>GenSup Amps</b> setting for 1 to 2 seconds.</p> <p>The Conext XW+ uses stored battery energy to load share with the generator until the total AC load current (generator plus Conext XW+ output) drops by 2 amps plus 10 per cent of the <b>GenSup Amps</b> setting for 0.5 seconds.</p> <p>For example, if <b>GenSup Amps</b> is set to 10 amps, the Conext XW+ starts to support when the load exceeds 10 amps for 2 seconds and stops when it drops more than 3 amps below the <b>GenSup Amps</b> setting, or 7 amps (2 amps plus 10 per cent of 10 amps = 3 amps).</p> <p>The system can enter this state if the battery voltage is above <b>Low Batt Cut Out +2V</b> and generator support is enabled. See “Generator Support Settings” on page 3–34.</p>
Grid Support	<p>There is AC input from the utility grid on AC1, however the priority for the Conext XW+ is to supply energy converted from external DC sources to the critical loads on AC Out.</p> <p>The Conext XW+ enters this state only when <b>Grid Support</b> is set to ON and battery voltage is above the <b>Grid Supp Volts</b> setting. See “Grid Support Settings” on page 3–25.</p>
APF Mode	APF (Active Power Frequency) mode is active. APF mode automatically injects or reduces active power to the grid based on a predefined frequency to power relationship. APF settings are only available through the Conext Configuration Tool. For further details, see the <i>Conext Configuration Tool Owner's Guide</i> .
Load Shaving	<p>The Conext XW+ supports the utility grid when there is AC input on AC1 and the current required to power the loads rises above the <b>Load Shave Amps</b> setting between the <b>Load Shave Start</b> and <b>Load Shave Stop</b> times set on the <b>Grid Support</b> menu.</p> <p>When load shaving, the Conext XW+ uses stored battery energy to reduce the peak load on the AC1 input by providing the difference between the actual load current and the <b>Load Shave Amps</b> setting. The Conext XW+ enters this state only when <b>Grid Support</b> is enabled, the load shave time window is valid and the load draw exceeds the <b>Load Shave Amps</b> setting. The battery voltage must also be between + 2 VDC and the Grid Support Volts setting. See “Grid Support Settings” on page 3–25.</p>

**Table 2-1** Conext XW+ Home Screen States

Conext XW+ Status	Displayed When...
Search	Search mode is enabled and the Conext XW+ is standing by, waiting to begin inverting. See “Using Search Mode” on page 3–9.
SellToGrid	The Conext XW+ is grid-tied and is exporting energy to the utility grid on AC1. Both <b>Grid Support</b> and <b>Sell</b> must be enabled in order to sell power back to the utility. See Table 3-1, “Conext XW+ Setup Menu” on page 3–2 and “Grid Support Settings” on page 3–25. All configurations must comply with local and national electrical codes.
Standby	The unit has been placed in standby mode using the <b>Mode</b> setting on the Conext SCP <b>Setup</b> menu, the Standby button on the Conext SCP, or the Standby key press (STARTUP/SHUTDOWN and Equalization) on the inverter information panel.
Passthru	The AC connected to the AC1 or AC2 input is passing directly through the Conext XW+ to the loads attached to AC Out. The batteries are not being charged in this state.
Equalize	Equalization has been turned on and the Conext XW+ is equalizing the batteries after completing a full charge cycle.

## Reading the Meters Screen

The **Meters** screen displays total system power production, grid voltage and current status, and load voltage and current status.

To view the **Meters** screen:

- On the Conext XW+ setup menu, highlight **Meters** and press **Enter**.

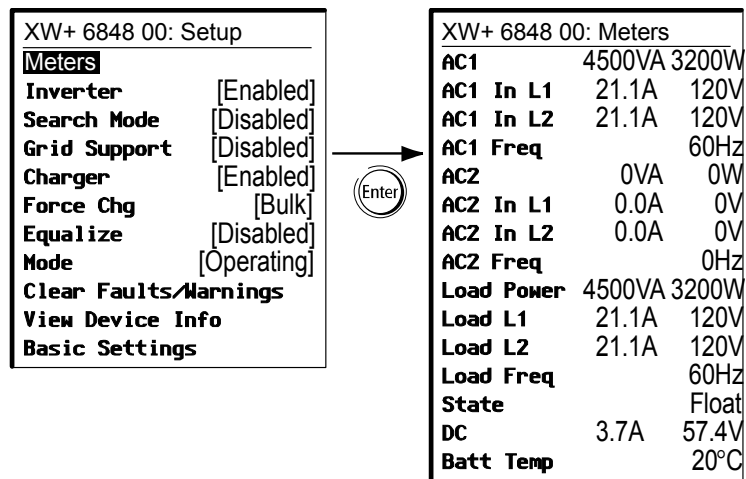
**Figure 2-8** Viewing the Meters Screen

**Table 2-2** Meters Screen

Screen Item	Description
AC1	AC input power connected to the Conext XW+ AC1 terminals, in volt-amperes and watts. AC1 is assumed to be connected to the utility grid, but can be connected to any other AC source.
AC1 in L1	AC input voltage and current connected to the Conext XW+ AC1 L1 terminals. This input voltage display may drift slightly before the Conext XW+ has synchronized to the grid.
AC1 in L2	AC input voltage and current connected to the Conext XW+ AC1 L2 terminals. This input voltage display may drift slightly before the Conext XW+ has synchronized to the grid.
AC1 Freq	AC frequency connected to the Conext XW+ AC1 terminals.
AC2	AC input power connected to the Conext XW+ AC2 terminals, in volt-amperes and watts. AC2 is assumed to be connected to a generator, but can be connected to any other AC source.
AC2 in L1	AC input voltage and current supplied to the Conext XW+ from the AC2 L1 input. This meter indicates the Conext XW+ is drawing power from the generator to charge the battery or power the AC loads.
AC2 in L2	AC input voltage and current supplied to the Conext XW+ from the AC2 L2 input. This meter indicates the Conext XW+ is drawing power from the generator to charge the battery or power the AC loads.
AC2 Freq	AC frequency connected to the Conext XW+ AC2 terminals.
Load Power	Power consumed by the AC loads attached to AC OUT, in volt-amperes and watts.
Load L1	AC voltage and current supplied from L1 to the AC loads on AC OUT.
Load L2	AC voltage and current supplied from L2 to the AC loads on AC OUT.
Load Freq	AC frequency supplied to the AC loads on AC OUT.
State	Operating state of the Conext XW+. For more information, see Table 2-1 on page 2–15.
DC	Charging current and battery voltage.
Batt Temp	Battery temperature as read by the BTS, connected to the Conext XW+. If the BTS is connected to a different device on the Xanbus network, please see the Meters screen for that device for temperature data. All Xanbus devices on the Xanbus network will share temperature data for temperature compensated charging. However, the temperature is only displayed on the meters screen for the device with the BTS installed. The BTS which is monitoring the device displaying the highest temperature will take priority. If the BTS is not installed, it shows <b>Not Available</b> .

# 3

## Configuration

Chapter 3, “Configuration” explains how to navigate through the Conext System Control Panel menus and configure the Conext XW+ Inverter/Charger.

Topics in this chapter include:

- “Using the Conext System Control Panel” on page 3–2
- “Using the Setup Menus” on page 3–4
- “Inverter Settings Menu” on page 3–8
- “Charger Settings Menu” on page 3–11
- “AC Input Settings” on page 3–23
- “Grid Support Settings” on page 3–25
- “Generator Support Settings” on page 3–34
- “Auxiliary Output Settings” on page 3–36
- “Multi-Unit Config Menu” on page 3–39
- “Connections Menu” on page 3–45
- “Copying Settings From Another Unit” on page 3–47
- “Resetting the Conext XW+ to Default Settings” on page 3–48
- “Using the Advanced Features” on page 3–49

## Using the Conext System Control Panel

The Conext XW+ is configured using the Conext SCP (Conext System Control Panel). The Conext SCP provides access to settings relating to AC input and output, battery charging, and grid-tie operation.

### Conext XW+ Setup Menu

The Conext XW+ **Setup** menu is accessible either from the system **Home** screen or from the Conext XW+ **Home** screen.

**To navigate to the Conext XW+ Setup menu:**

1. From the system **Home** screen, press **Enter** to view the **Select Device** menu. Or from the Conext XW+ **Home** screen, press **Enter**. The Conext XW+ **Setup** menu appears. Go to step 2.
2. Highlight the Conext XW+ device name, then press **Enter**.

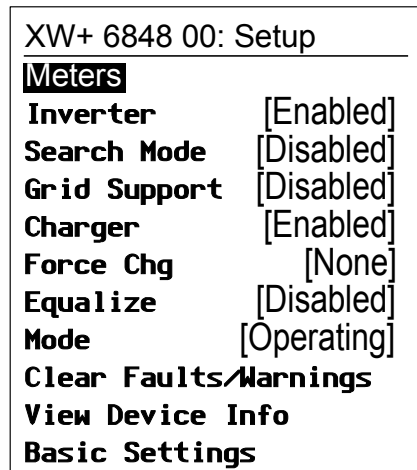

**Note:** The Conext SCP only displays four lines of the **Setup** menu at once. To view additional settings, press the Down arrow button.

**Figure 3-1** Conext XW+ Setup Menu

**Table 3-1** Conext XW+ Setup Menu

Menu Item	Description
Meters	Displays the <b>Meters</b> screen.
Inverter	Enables or disables the inverter.
Search Mode	Turns <b>Search Mode</b> on and off. See “Using Search Mode” on page 3–9.



**Table 3-1** Conext XW+ Setup Menu

Menu Item	Description
Grid Support	Enables or disables grid-interactive Conext XW+ features, such as grid support and grid sell mode. See “Grid Support Settings” on page 3–25. To allow grid support to function after battery charging has completed, it is recommended to set the Charge Cycle to 2-Stage. The MPPT controllers must still be set to 3-stage. See “Charger Settings Menu” on page 3–11. When using load shave, turning ON Sell and setting Sell Amps to 0.0 is a way to make the net power flow to the grid zero. If sell is not enabled, there will be a net purchase of as much as 2.0 - 3.0 kWh per day due to the current control loop not allowing any outgoing current. If you wish to further reduce grid draw using this function, enable sell mode even if you do not wish to export power and set Max Sell Amps to a value of 0.
Charger	Enables or disables the charger.
Force Chg	Manually changes the charge stage to either bulk or float (when 3-Stage cycle is selected) or bulk or no float (when 2-Stage cycle is selected).
Equalize	Enables or disables battery equalization. This option is only available if the battery type is set to <b>Flooded</b> or is set to <b>Custom</b> with <b>Equalize Support</b> enabled.
Mode	Selects the Conext XW+ operating mode: <b>Operating</b> or <b>Standby</b> . The red Standby button on the Conext SCP has similar functionality (see “Conext System Control Panel Features” on page 2–10).
Clear Faults/ Warnings	Clears any active faults or warnings. If the fault or warning condition is still present, the fault or warning message may reappear.
View Device Info	Displays the <b>Device Info</b> screen where you can view the warning, fault, and event logs.
Basic Settings	Select to display and/or adjust the basic Conext XW+ settings. See “Using the Setup Menus” on page 3–4.

## Setting the Time and Date

Conext XW+ advanced features such as peak load shaving, charger block, and time-stamped events (faults, warnings, and logged historical data) require that the system be set to the correct time. The Conext SCP has an internal clock that controls the time for the Xanbus-enabled devices in the system. You can set the time, time format, and date on the **Clock** menu. The **Clock** menu is accessible on the **Select Device** menu.

For more information, see “Setting the Time” and “Setting the Date” in the *Conext System Control Panel Owner’s Guide*.

**Note:** Network time on the ComBox overrides time configured on any individual device in the network-enabled power system using network time protocol (NTP).

If your device is not compatible with NTP, Conext XW+ features such as peak load shaving and charger block may not work correctly, and charge controller daily power production values may reset at an unexpected time. If your device is working incorrectly, configure the ComBox to use the local time and date. See the *ComBox Owner's Guide* (document part number: 975-0679-01-01) for more information.

---

## Using the Setup Menus

### Basic menu

The Conext XW+ configuration settings can be viewed in basic and advanced formats (see Figure 3-3, “Basic and Advanced Settings” on page 3–7). The basic settings include configuration items you may have to adjust routinely, or as part of initial setup.

### Advanced menu

The advanced settings option gives you access to the full range of Conext XW+ settings, including everything displayed on the basic menu. As a safeguard against unintended advanced configuration, the Conext SCP displays the basic settings by default. To view the advanced settings, you must perform a special keypress.

### **▲ WARNING**

#### **ADVANCED CONFIGURATION HAZARD**

Advanced menu settings should be used by qualified personnel only.

Three phase operation should be configured by qualified personnel only.

Consult with the local utility before enabling Conext XW+ sell mode or grid support functions.

Do not change these settings unless you are under the supervision and direction of qualified personnel.

**Failure to follow these instructions can result in death or serious injury.**

#### **To select the Advanced settings:**

1. On the **Select Device** menu, select a Conext XW+.
2. Press and release **Enter + up arrow + down arrow** at the same time.

---

#### **Notes:**

- This keypress enables the advanced settings for every device in the system.
  - After performing the keypress, **Advanced Settings** appears at the top of the Setup menu. When the keypress is performed again, the Setup menu displays **Basic Settings** as the last item on the menu.
-

The Conext XW+ advanced settings include menus for configuring:

- Inverter settings (see page 3–8)
- Charger settings (see page 3–11)
- AC transfer limit settings (see page 3–23)
- Grid support and peak load shaving settings (see page 3–25)
- Generator support settings (see page 3–34)
- Auxiliary output settings (see page 3–36).
- Multi-unit operation, including customizing the default model name of the Conext XW+ and setting its network device number. Setting the device number is important when multiple Conext XW+ units are on the Xanbus network and sharing connections such as AC loads, utility grid, and generator. The device number is also used when configuring paralleled Conext XW+ units for master-slave operation (see “Inverter Settings Menu” on page 3–8).

In the advanced settings you can also copy another unit’s settings using the **Copy from** command.

**To view the advanced or basic settings:**

- From the **Setup** menu, with **Basic Settings** or **Advanced Settings** highlighted, press **Enter**. See Figure 3-2.

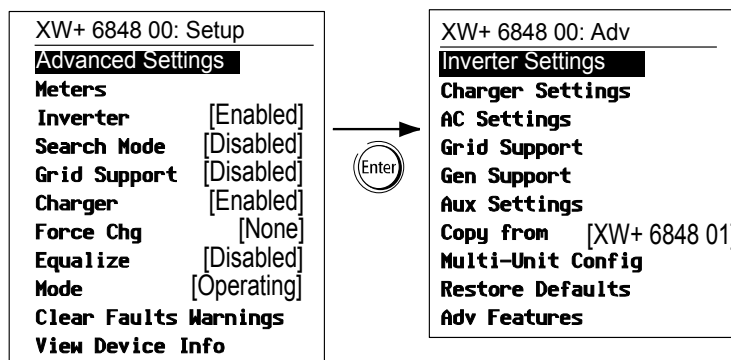

**Figure 3-2** Selecting Advanced Settings

**To select and change a configurable setting:**

1. On the desired configuration menu, press the up arrow or down arrow button to highlight the setting you want to change.
2. Press **Enter** to highlight the current value of the setting.
3. Press the up arrow or the down arrow button to change the value. Hold down the button to scroll through a large range of values quickly.  
The previously set value appears with an asterisk (\*) beside it.
4. Press **Enter** to select the value.

5. If you have another setting to change, return to step 1. Or if you have no more settings to change, press **Exit** until the Conext SCP displays the desired screen or menu.

---

**Note:** If you have no more settings to change, it is recommended to leave the **Setup** menu in the basic settings format to help prevent unintended configuration. If the **Setup** menu displays **Advanced Settings**, press **Enter + up arrow + down arrow** at the same time. The Setup menu should then display **Basic Settings** as the last item on the menu.

---

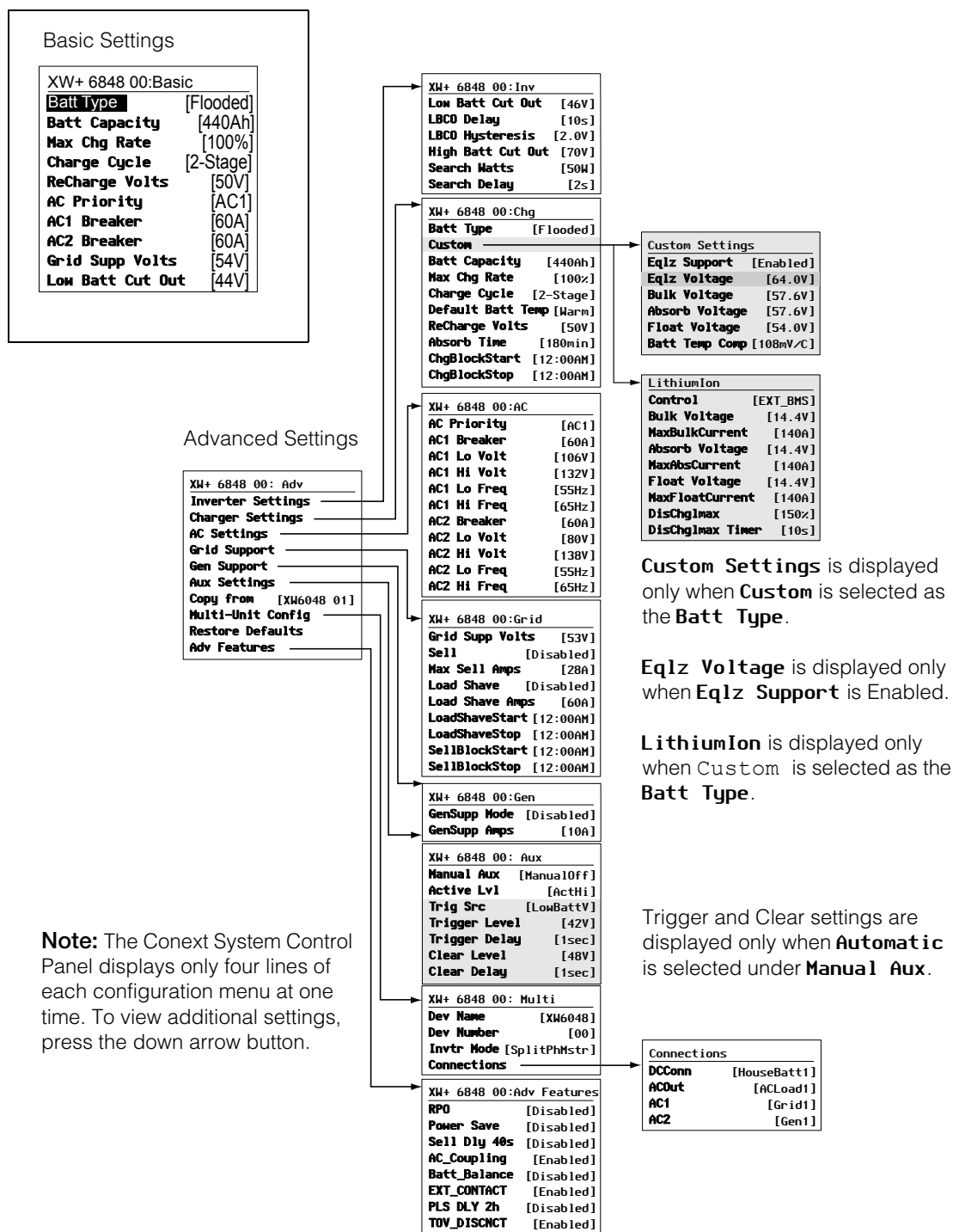

Figure 3-3 Basic and Advanced Settings

## Inverter Settings Menu

The **Inverter Settings** menu contains settings that control when the Conext XW+ starts and stops producing AC output.

**Table 3-2** Inverter Settings Menu

Item	Description
Low Batt Cut Out	Low Batt Cut Out controls when the inverter stops producing AC output due to a low battery voltage condition. The inverter will stop producing AC output only after this level has been reached for the period of time set by the <b>LBCO Delay</b> . This setting is not temperature compensated.
LBCO Delay	LBCO Delay controls how long the inverter is allowed to operate at or below the <b>Low Batt Cut Out</b> level before turning off due to a low battery voltage condition. The inverter will stop producing AC output only after the <b>Low Batt Cut Out</b> level has been reached for this uninterrupted period of time.  Once the inverter has shut off, the battery voltage must rise 4 volts above the <b>Low Batt Cut Out</b> setting for inverter operation to resume.
High Batt Cut Out	<b>High Batt Cut Out</b> sets the maximum battery voltage at which the inverter will operate. If the battery voltage exceeds this limit for more than 1 minute, the Conext XW+ displays a fault message (F49) and shuts down. The inverter will not support AC loads when in this condition. If a qualified AC source is present, the unit passes AC through to the loads. The inverter automatically restarts when the voltage drops to 6 volts below the <b>High Batt Cut Out</b> setting. If battery voltage continues to rise after shutdown, an external charger may still be charging the batteries. The Conext XW+ cannot control how external chargers operate.
Search Watts	Search Watts sets search sensitivity for the Conext XW+ when search mode is enabled. When a load larger than this setting is present on AC OUT, the inverter starts producing AC output from battery power. Enabling search mode from the <b>Setup</b> menu (see page 3–2) can minimize power draw from the battery during periods of low demand from loads. Also see “Using Search Mode” on page 3–9.
Search Delay	Search Delay sets the time between search pulses. When searching for loads, the Conext XW+ sends out search pulses on AC OUT to determine the presence of a load above <b>Search Watts</b> . Conext XW+ power draw while in search mode decreases when <b>Search Delay</b> is increased, but the Conext XW+ response time to active loads is slower.

For default settings, see “Inverter Settings Menu” on page B–3.

## Using the Low Battery Cut Out and LBCO Delay Settings

### ⚠ WARNING

#### ADVANCED CONFIGURATION HAZARD

Advanced menu settings should be used by qualified personnel only.

Three phase operation should be configured by qualified personnel only.

Consult with the local utility before enabling Conext XW+ sell mode or grid support functions.

Do not change these settings unless you are under the supervision and direction of qualified personnel.

**Failure to follow these instructions can result in death or serious injury.**

The **Low Batt Cut Out** setting is the lowest battery voltage level acceptable for use by the inverter. When the batteries discharge to the **Low Batt Cut Out** setting, and are held at or below this level for the **LBCO Delay** time, the inverter output shuts down and connects any available AC source (AC1 or AC2) to the charger to bring the battery level back above the **Low Batt Cut Out** setting. After shutdown, the inverter does not support loads on AC OUT, and AC loads must be powered by either a generator (AC2) or grid power (AC1). If the battery voltage stays below the LBCO voltage for more than 24 hours, the Conext XW+ shuts down.

- If using the Conext Automatic Generator Start system, it is recommended to set the Conext AGS voltage trigger setting higher than the Conext XW+ **Low Batt Cut Out** voltage.
- Although not recommended, if using the Conext Automatic Generator Start system with the start trigger set to the same voltage as the LBCO voltage, do not set the **LBCO Delay** for less than the amount of time it takes the generator to start and connect.

Otherwise – in both of the scenarios above – inverter output turns off before the generator automatically starts, causing the battery voltage to recover slightly. This may then stop the Conext AGS from starting the generator or result in the Conext XW+ cycling on and off multiple times before the generator automatically starts.

## Using Search Mode

### Why use Search mode?

Search mode allows the inverter to selectively power only items that draw more than a certain amount of power, which can result in energy savings. The Conext XW+ has a no-load power draw of about 28 watts. Enabling search mode reduces this power draw to less than 8 watts. Search mode operates differently in single-unit and multi-unit installations.

**Single units** When a single Conext XW+ has search mode enabled, the inverter sends electrical search pulses through its AC output. These search pulses look for connected AC loads. The delay between search pulses is set using the **Search Delay** setting. After a load larger than the **Search Watts** setting is detected, the inverter starts producing AC output.

**Multiple units** To use search mode in multiple unit installations with paralleled Conext XW+ units, the master unit must have search mode disabled. Slave units must have search mode enabled.

When search mode is disabled on the master unit and enabled on slave units, only the master Conext XW+ operates, and the slave units start to support the load only when the load exceeds approximately 60 per cent of the rated output power of the master unit. In a three-unit system, the third slave unit starts to support the load if the load on the master is above 60 per cent of its rated power for about 3 to 5 seconds. When the load drops below 20 per cent of the master's rated output power, the slave units stop producing AC output in reverse order, which means that the last slave unit to start is the first to stop.

**When to set up Search mode** The search mode feature is only valuable if the inverter can spend a fair amount of time "sleeping" each day. Therefore, if search mode is to be used it must be adjusted properly. The initial adjustment should be made so that the Conext XW+ comes on only when needed.

Certain types of loads can cause search mode to work improperly. These types of loads are described in "Inverter Applications" on page 4-3. If these kinds of loads are in the system, follow the suggestions given to resolve the problem.

If the problem loads cannot be resolved, there are two workaround solutions:

1. Disable search mode from the main Conext XW+ Setup menu, causing the inverter to remain at full output voltage.
2. Use a search friendly companion load whose only purpose is to be switched on to wake up the inverter to power the load that is unable to bring the inverter out of search mode.

---

**Notes:**

- Search mode, by function, cannot work with clocks and timers or devices that need power 24 hours a day. Examples of devices with timers include video recorders, coffee makers with brew timers, refrigerators, and freezers with defrost timers. Examples of devices that need power 24 hours a day include telephone answering machines, alarm systems, motion detection lights, and some thermostats.
  - When the inverter is searching the output for loads, lights that have a wattage lower than this setting may flash momentarily.
-



## Charger Settings Menu

The **Charger Settings** menu provides options for configuring the Conext XW+ to operate from your battery bank.

**Table 3-3** Charger Settings Menu

Item	Description
Batt Type	<p>Sets the system battery chemistry and type: <b>Flooded</b> (default), <b>AGM</b>, <b>Ge1</b>, <b>LithiumIon</b>, and <b>Custom</b>.</p> <p>Selecting <b>Custom</b> displays the <b>Custom Settings</b> item, which allows you to adjust the settings for each charging stage.</p>
Custom Settings	<p>Displays the <b>Custom Battery Settings</b> menu, where you can adjust settings specific to your battery type and installation. It is displayed if <b>Custom</b> is selected as the <b>Batt Type</b>. Further custom settings for Lithium Ion batteries appear if <b>Lithium Ion</b> is selected as the <b>Batt Type</b>.</p>
Batt Capacity	<p>Selects the system battery capacity in Ah (amp hours). Setting the <b>Batt Capacity</b> to 0 resets the charging current to its default values. Zero Ah battery capacity implies there is no absorption exit current criteria and absorption only exits when the absorption timer (default 3 hours, range 1 minute-8 hours) expires.</p>
Max Chg Rate	<p>Sets the percentage of the maximum DC output current that is available to the charger. The maximum DC output current for different models is:</p> <ul style="list-style-type: none"> <li>• Conext XW+ 5548 NA—110 A</li> <li>• Conext XW+ 6848 NA—140 A</li> </ul> <p>If multiple Conext XW+ Inverter/Chargers are charging the same battery bank, set each inverter's <b>Max Chg Rate</b> to 1/n of the desired charge rate (where n is the number of inverterchargers).</p> <p><b>Note:</b> Always refer to the battery manufacturer's specifications before setting the Max Chg Rate. Do not set the Max Chg Rate above these specifications.</p>
Charge Cycle	<p>Sets the charging method: <b>3-Stage</b> (bulk, absorption, float) or <b>2-Stage</b> (bulk, absorption, no float).</p>
Default Batt Temp	<p>Selects the battery temperature charging compensation if a battery temperature sensor is not installed. In the absence of a battery temperature sensor, the charger uses one of three settings: <b>Cool</b> (5 °C/41 °F), <b>Warm</b> (25 °C/77 °F), or <b>Hot</b> (40 °C/104 °F).</p>
ReCharge Volts	<p>When charger is set for 2-stage operation, sets the battery voltage level at which a new charge cycle begins. <b>ReCharge Volts</b> is automatically temperature compensated to be consistent with the charge voltage (also temperature compensated).</p>
Absorb Time	<p>Sets the maximum time spent in the absorption stage, before transitioning to float or no float.</p>
Chg Block Start	<p>Sets the time to halt charging on AC1 (Grid). The AC2 (Gen) port is unaffected by the Conext XW+ block settings. The charger block start and stop settings allow you to select when the charger stops charging on AC1. To disable the charger block function, set <b>Chg Block Start</b> and <b>Chg Block Stop</b> to the same time. See "Charger Block" on page 3-31.</p>

**Table 3-3** Charger Settings Menu

Item	Description
Chg Block Stop	Sets the time that charging on AC1 can resume. At the <b>Chg Block Stop</b> time, charging on AC1 is enabled again.

For default settings, see “Charger Settings Menu” on page B-3.

## Battery Charger Functions

When AC power is available, the Conext XW+ can operate as a battery charger. Different battery types and chemistries require different charging voltage levels. Not charging batteries at the required levels can shorten battery life or damage the batteries. The Conext XW+ is configured at the factory to work with the battery types recommended for inverter applications. If the default settings do not work for your specific installation, you can adjust the charge stage settings (as recommended by the battery manufacturer) on the **Custom Battery Settings** menu (see page 3-21).

---

**Note:** This information is provided for guidance only. Variations in battery chemistry and site-specific environmental considerations mean that you should consult your system designer or battery manufacturer for specific recommendations for appropriate battery voltage and current settings.

---

## Multi-Stage Charging Process

The charging cycle is a multi-stage process. Whenever qualified AC power is present at the AC1 or AC2 input, power runs through to the connected load and begins charging the batteries in parallel.

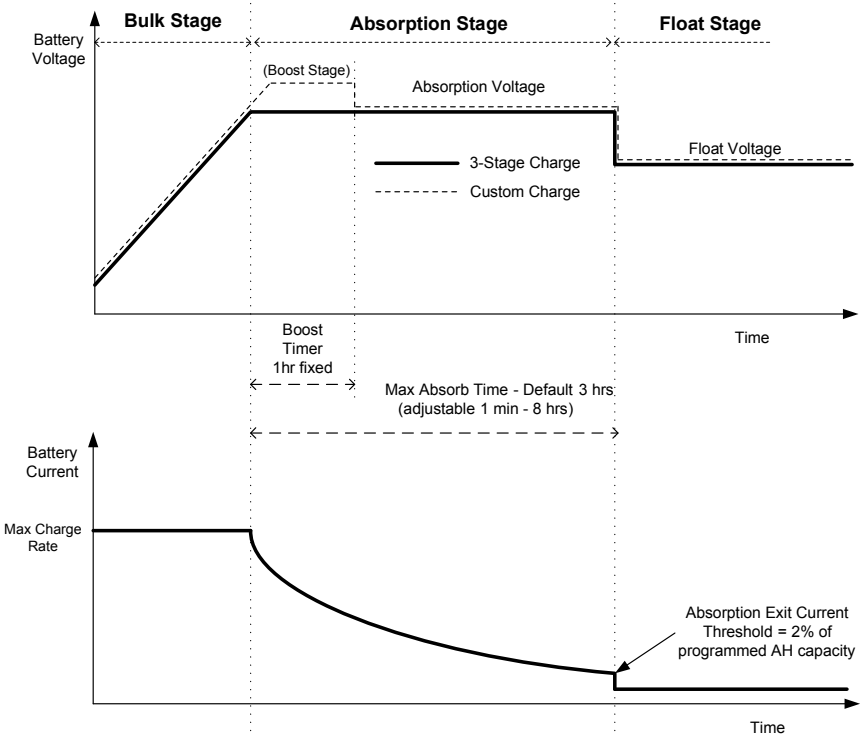

Figure 3-4 Three-Stage Battery Charging Cycle

**Notes:**

When the charge cycle is interrupted, the charger will restart charging at the beginning of the multi-stage algorithm.

Exit Current Threshold can be effectively disabled by programming the amp-hour capacity to 0. In this case, absorption will only exit once the Max Absorption timer expires.

Charge current during equalize state (optional state not shown here) is normally limited to 10% of the programmed amp-hour capacity setting. If this setting is programmed to 0 Ah, the charge current during equalize is instead limited to whatever is programmed for the maximum current limit of the unit (the default current limit in equalize mode is 60 A).

Synchronized charge states are active when more than one charging device (Conext XW+ or Conext Solar Charge Controller) is connected in the system via the Xanbus network.

- The first Conext XW+ or Conext Solar Charge Controller to enter bulk, causes the other chargers to enter bulk.
- The first Conext XW+ to enter absorption causes the other chargers to enter absorption.
- The last Conext XW+ ready to exit absorption triggers the rest to exit absorption and exit charge. The Conext XW+ will not wait for any connected Conext Solar Charge Controllers to transition to absorption or float.

---

**Bulk Stage**

Bulk charge is the first stage in the charging process and provides the batteries with a controlled, constant current. Once the battery voltage rises to the bulk voltage threshold, the charger switches to the absorption stage.

**Absorption Stage**

During the absorption stage, the Conext XW+ begins operating in constant voltage mode and the DC charge current falls gradually as energy is returned to the battery. For the first 60 minutes of the absorption stage, the Conext XW+ regulates the battery voltage at the **Bulk Voltage** setting. The voltage limit used for the remaining time in this stage is the **Absorption Voltage** setting. By default, the bulk and absorption voltage settings are the same for each battery type. The voltage limit settings for bulk and absorption can be adjusted independently if the battery type is set to **Custom**. The Conext XW+ transitions to the float stage if either one of the following two conditions are met:

1. The charge current allowed by the batteries falls below the exit current threshold, which is equal to 2% of the programmed battery capacity (for a 500 Ah battery bank, this would be 10 A), for three minutes.
2. The Conext XW+ has been in absorption for the programmed maximum absorption time limit. The default is 3 hours, but the time limit is programmable from 1 minute to 8 hours.

**Note:** If there are DC loads on the batteries, the charger's current may not decrease to a level to transition to the next stage of charging. In this case, the charger stays in absorption until the **Absorb Time** setting is reached.

To avoid having the charger remain in absorption for too long, adjust **Absorb Time** on the **Charger Settings** menu. The timer begins at the start of the absorption stage and terminates absorption charging if the charge current does not decrease to below 2 per cent of the battery capacity before the **Absorb Time** setting expires. The **Absorb Time** setting may be increased if the charge cycle continually runs the complete **Absorb Time** in the absence of DC loads. This is an indication of too large a battery bank for the selected **Absorb Time** setting.

---

## Boost Charging

Boost charging allows for better utilization of flooded lead acid batteries under moderate cycling in off-grid or grid support applications. Boost charging encourages a short duration charging voltage—above the gassing voltage—at the beginning of the absorption charge state. Testing has shown that boost charging improves battery performance by providing a regular mixing of the liquid electrolyte. Boost charging specifically discourages capacity robbing acid stratification and plate sulfation.

Boost mode charging can be enabled by selecting the Custom battery type and by setting the bulk voltage higher than the absorption voltage. The multi-stage charge algorithm then attempts to use the higher for the first hour of the absorption stage, unless it is interrupted by the max absorption timer or exit current threshold.

- Boost charging encourages gassing of flooded lead acid batteries.
- Boost charging is NOT recommended for AGM, GEL or any other electrolyte-limited and/or valve-regulated sealed battery application.
- Boost charging may result in higher than normal water consumption. However, the benefits of boost charging are likely to be greater than the extra watering effort. Check battery water levels at least once per month.

Boost charging has maximum benefit when used on batteries that experience moderate cycling. An unoccupied cottage, for example, where batteries are full the majority of the time may not benefit from boost charging, especially if battery watering is difficult.

For equalize charging, a custom Boost charge profile can be configured if the equalize method is not periodically used. Boost charging occurs in the first hour of the absorption stage. It allows for a higher constant voltage than absorption voltage to encourage a “mini equalize” each time the battery is charged.

The boost voltage is defined by the **Bulk Voltage** setting. The Conext system will still allow manual equalize charging when the boost absorption voltage is implemented. This is for advanced users only who pay strict attention to battery maintenance and have an appropriately vented and protected battery installation. Consult your battery manufacturer for appropriate voltages.

### Float Stage

Float charge maintains the batteries slightly above the self discharge voltage of the batteries. The charge current in float is the current necessary to maintain the batteries at the **Float Voltage** setting, limited only by the inverter's capability or other settings that limit the inverter's maximum charge rate. Float charging reduces battery gassing, minimizes watering requirements (for flooded batteries), and helps the batteries remain in a constant state of readiness. When three-stage charging is selected, the charger automatically switches to the float stage after the batteries have received a bulk and absorption charge (see Figure 3-4, "Three-Stage Battery Charging Cycle" on page 3–13). The batteries are maintained at the default float voltage level for the selected battery type or the voltage selected under **Float Voltage** on the **Custom Battery Settings** menu.

---

**Note:** The battery voltage can increase above the float voltage when using an external charging device such as charge controllers attached to PV arrays, wind turbines, and micro-hydro generators. Be sure to include appropriate charge management equipment with all external DC sources.

---

### Two-Stage

Two-stage (or no float) mode differs from an ordinary three-stage charge mode in that it does not continuously maintain the battery at float voltage. Instead, the Conext XW+ begins charging the battery in bulk mode whenever the battery voltage drops below the recharge level. While the battery voltage is above the recharge level the inverter's AC transfer switch continues to pass power through from the utility grid to the loads, but does not actively charge the batteries.

Two-stage mode increases efficiency of utility connected systems by reducing the amount of power consumed by the inverter and batteries compared to when the battery is continuously maintained at **Float Voltage**. This feature can extend the life of many batteries.

To allow grid support and sell mode to function after battery charging has completed, it is recommended to set **Charge Cycle** to **2-stage**.

---

**Note:** If the AC input stops or drops below the lower VAC limit (as set in **AC Settings**), the complete multi-stage charge cycle (bulk, absorption, float/no float) restarts once the source AC recovers to within the acceptable range. If the batteries are already nearly full, the charge cycle will take little time to complete.

---

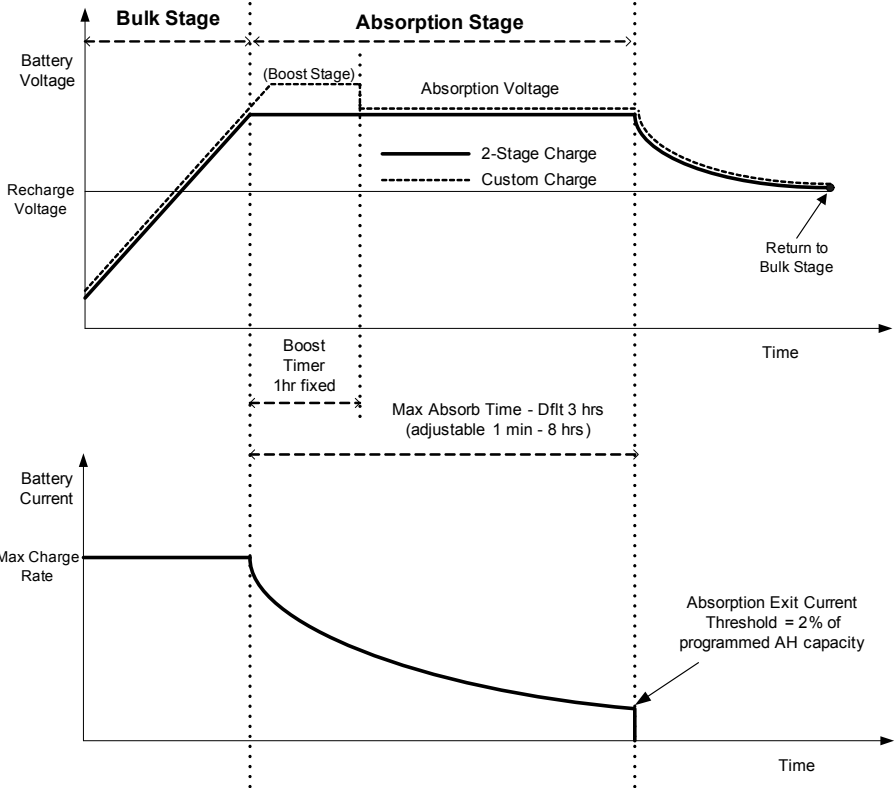

Figure 3-5 Two-Stage Charging Cycle

**Note:**

When the charge cycle is interrupted, the charger will restart charging at the beginning of the multi-stage algorithm.

Exit Current Threshold can be effectively disabled by programming the amp-hour capacity to 0. In this case, absorption will only exit once the **Max Absorption** timer expires.

Charge current during equalize state (optional state not shown in graph) is normally limited to 10% of the programmed amp-hour capacity setting. If this setting is programmed to 0 Ah, the charge current during equalize is limited to whatever is programmed for the max current limit of the unit (the default current limit in equalize mode is 60 A).

Synchronized charge states are active when more than one charging device (Conext XW+ or Conext Solar Charge Controller) is connected in the system via the Xanbus network.

- The first unit (Conext XW+ or Conext Solar Charge Controller) to enter bulk, causes the other chargers to enter bulk.
- The first Conext XW+ to enter absorption causes the others to enter absorption.
- The last Conext XW+ ready to exit absorption triggers the others to exit absorption and exit charge. The Conext XW+ will not wait for any connected Conext Solar Charge Controllers to transition to absorption or float.

---

## Equalize Charging

Many lead acid battery manufacturers recommend periodic equalize charging to counter cell charge imbalance and capacity robbing sulphation. Equalizing helps to improve battery performance and lifespan by encouraging more of the battery material to become active.

Battery equalization is a controlled overcharging method that reduces sulphation and mixes up stratified electrolyte and reactivates unused areas of the plate material. Periodic equalizing can help to regularly restore flooded lead acid batteries to a healthy state of charge.

Consult the battery manufacturer's recommendation for equalize charging settings. Sealed lead acid, gel, AGM, and lithium ion batteries should not be equalized unless recommended by the battery manufacturer. Consult the battery manufacturer for optimal charging procedures when using sealed batteries.

When **Equalize** mode is enabled, the battery is charged from bulk to absorption, and then to the equalize phase. The Conext XW+ will transition from the absorption phase to equalize if:

- The DC charge current is below 2% of the configured battery capacity (for example, 8.8 A for 440 Ah).
- The absorption time is exceeded (for example, 180 minutes).



After absorption, the maximum charge DC current is set to 10% of battery capacity (for example, 44 A for 440 Ah). See Figure 3-6. This constant current charge will continue until the voltage has increased to the equalize voltage at which point the battery will be regulated at the temperature compensated equalize voltage.

If the battery capacity is set to zero, the equalize charge current is fixed at maximum 44 A (Ah=0 effectively disables the exit current criteria for the absorption charge stage, making the absorption stage defined by time only).

Equalization duration is fixed at one hour.

**Note:** The graphs below apply only to flooded battery types.

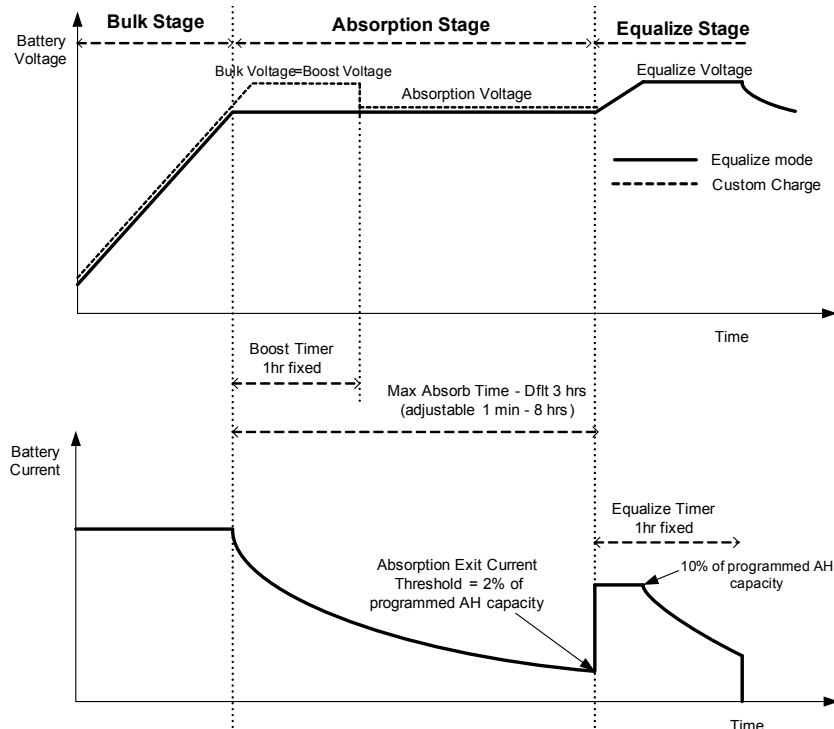

Figure 3-6 Equalize Charging

## Equalization Procedure

To start equalizing the batteries, do one of the following:

- On the Conext Setup menu, highlight **Equalize** and select **Enable**.
- Press the **Equalize** button on the inverter information panel for five seconds.

If the Conext XW+ will not perform the equalization, see Warning W96 “Cannot Equalize” in Table 4-3 on page 4–12.

**⚠ WARNING**

**EQUALIZATION HAZARD**

Only flooded lead acid batteries should be equalize charged. Hydrogen and oxygen gases are produced when batteries are equalized and can potentially cause an explosion if ignited. Corrosive battery acid can escape.

Provide adequate ventilation and remove all sources of ignition, such as open flames, sparks, electric motors, relays, light switches, etc.

Equalization voltage is significantly higher than nominal battery voltage. Detach electronics that can be damaged by high DC voltage.

**Failure to follow these instructions can result in death or serious injury.**

---

**Note:** In a system where more than one device is capable of equalizing batteries (such as a system including multiple Conext XW+ units and Conext Solar Charge Controllers), there is no system-wide equalization command for all devices. To equalize with multiple devices, each would have to be enabled individually. Alternatively, equalization can be performed using only one device. During the equalization process, one device applies the equalization charge while the other devices continue to operate in synchronized charge mode, typically in float (three-stage charging) or no-float (two-stage charging).

---

## Custom Battery Settings Menu

**⚠ WARNING**

**BATTERY TYPE AND SETUP HAZARDS**

Incorrect battery configurations or settings for battery types can lead to dangerously high battery temperature, fire and explosion. To avoid damaging your batteries during charging or equalization, and to minimize the risk of fire or explosion consult battery manufacturer's documentation before setting battery parameters and follow the battery manufacturer's recommended settings.

- Always use and connect the Battery Temperature Sensor (BTS).
- Always verify that the configured battery type matches the battery type being used.
- Custom battery settings should be configured by qualified personnel only.
- When using Lithium-Ion batteries, ensure that the battery pack being used includes a Battery Management System (BMS) with safety controls.

**Failure to follow these instructions can result in death or serious injury.**

Further details about Lithium Ion support can be found in the document “*Lithium Ion Application Note (Document Number: 976-0319-01-01)*” available at [solar.schneider-electric.com](http://solar.schneider-electric.com).

### ▲ WARNING

#### ADVANCED CONFIGURATION HAZARD

Advanced menu settings should be used by qualified personnel only.

Three phase operation should be configured by qualified personnel only.

Consult with the local utility before enabling Conext XW+ sell mode or grid support functions.

Do not change these settings unless you are under the supervision and direction of qualified personnel.

**Failure to follow these instructions can result in death or serious injury.**

The **Custom Battery Settings** menu can be viewed if **Custom** is selected as the **Batt Type**. This menu allows you to adjust charging and equalization voltage for batteries with specifications that fall outside the default settings for the battery types the Conext XW+ offers. You can also adjust the temperature compensation constant for the battery temperature sensor on this menu.

**Note:** The default settings for configuring a custom battery type are based on the default settings for a flooded battery type.

Table 3-4 describes the items on the **Custom Battery Settings** menu.

**Table 3-4** Custom Battery Settings Menu

Item	Description
Eqz Support	Enables or disables the ability to enter an equalization cycle. Refer to the battery manufacturer’s specifications to determine whether equalization is recommended.
Eqz Voltage <sup>a</sup>	Selects the equalization voltage. Consult your battery manufacturer for equalization voltage setting.
Bulk Voltage	Sets the bulk voltage for a custom battery type.
Absorb Voltage	Sets the absorption voltage for a custom battery type.
Float Voltage	Sets the float voltage for a custom battery type.

**Table 3-4** Custom Battery Settings Menu

Item	Description
Batt Temp Comp	<p>Battery temperature compensation for a custom battery type. This setting is the reference that the BTS uses to adjust the charging voltage when the temperature is above or below 25 °C (77 °F).</p> <p>The following voltage thresholds are not temperature compensated:</p> <ul style="list-style-type: none"> <li>• Grid Support entry voltage</li> <li>• Grid Support exit voltage</li> <li>• Low Battery Cut-Out trigger voltage</li> <li>• Low Battery Cut-Out condition clear voltage</li> </ul> <p>The following battery voltage set points are temperature compensated:</p> <ul style="list-style-type: none"> <li>• Float exit voltage</li> <li>• Bulk exit voltage</li> <li>• Float and Gassing voltages used in Constant Voltage exit criteria</li> <li>• Recharge Volts</li> <li>• Charge Control target voltage</li> </ul>
Max Bulk Current	Configures the current limit when the Conext XW+ is in Bulk Charge Mode.
Max Abs Current	Configures the current limit when the Conext XW+ is in Absorption Charge Mode.
Max Float Current	Configures the current limit when the Conext XW+ is in Float Charge Mode.
DisChglmax	Each Lithium Ion battery has an internal contactor and over load protection which is based on maximum current. If exceeded, the contactor may open, resulting in complete isolation of the battery pack, thus removing power to the Conext XW+. In this case the Xanbus communication as well as devices powered from the Conext XW+ could become unusable. When the Conext XW+ current draw exceeds the set value for a period defined in “DisChglmax Timer”, the Conext XW+ disables INV output.
DisChglmax Timer	Allows the Conext XW+ current in Invert mode to exceed the DisChglmax limit for inrush periods to startup loads such as pumps/motors. When the timer expires, the Conext XW+ disables INV output.

a. The **Eq1z Voltage** setting is displayed when **Eq1z Support** is set to **0n**.

For default settings, see “Custom Settings Submenu” on page B-3.

## AC Input Settings

### ⚠ WARNING

#### ADVANCED CONFIGURATION HAZARD

Advanced menu settings should be used by qualified personnel only.

Three phase operation should be configured by qualified personnel only.

Consult with the local utility before enabling Conext XW+ sell mode or grid support functions.

Do not change these settings unless you are under the supervision and direction of qualified personnel.

**Failure to follow these instructions can result in death or serious injury.**

The **AC Settings** menu configures the voltage and frequency limits for AC port 1 (Grid) and AC port 2 (Gen). These are the limits at which the Conext XW+ considers AC input voltage qualified—that is, suitable for charging batteries or passing through to loads attached to AC OUT. If the input voltage is not qualified according to these settings, the Conext XW+ reverts to inverting external DC energy to AC energy for loads on AC OUT.

### NOTICE

#### THREE-PHASE CONFIGURATION COMPATIBILITY

The Conext XW+ is configured from the factory as a split-phase inverter. In order to qualify the input, the AC input to the inverter must be split phase:  $V_{\text{Line1-Neutral}} + V_{\text{Line2-Neutral}} = V_{\text{Line1-Line2}}$ . The Conext XW+ can be converted and configured for single-phase operation (120 V only). A split-phase Conext XW+ cannot accept input from a three-phase source, so the inverter must be converted to single-phase operation and connected to a 120 V leg.

**Failure to follow these instructions can result in equipment damage.**

**Table 3-5** AC Settings Menu

Item	Description
AC Priority	<p>Sets the priority for the AC input source (AC1 or AC2) for qualification and transfer.</p> <p>In systems that use both utility grid (AC1) and generator (AC2) input, it is recommended that you set <b>AC Priority</b> to AC1. Assuming the generator is intended for occasional use only, the Conext XW+ will use utility power. It will use the generator only if AC1 is unavailable, and if the generator is running.</p>

**Table 3-5** AC Settings Menu

Item	Description
AC1 Breaker	<p>Sets the AC1 (Grid) breaker size, based on the size of the breaker installed upstream from the AC1 connection port. The installed breaker size must not exceed the capacity of the upstream distribution panel. The Conext XW+ limits the maximum current draw on AC1 by derating its charging current to an equivalent of 80% of the AC1 breaker setting.</p> <p>However, if the connected loads on AC OUT exceed the AC1 breaker setting, the upstream AC breaker trips. The breaker may not trip if grid support is enabled and battery voltage is above the <b>Grid Supp Volts</b> setting, or if peak load shave is enabled and the load shave time window is active.</p>
AC1 Lo Volt	Minimum acceptable input voltage level from the utility grid.
AC1 Hi Volt	Maximum acceptable input voltage level from the utility grid.
AC1 Lo Freq	Minimum acceptable utility grid input frequency.
AC1 Hi Freq	Maximum acceptable utility grid input frequency.
AC2 Breaker	<p>Sets the AC2 (Gen) breaker size, based on the size of the installed AC breaker upstream from the AC2 connection port. The installed upstream breaker and the AC2 breaker set point must not exceed the capacity of the generator. The Conext XW+ limits the maximum current draw on AC2 by derating its charging current to an equivalent of 80% of the AC2 breaker setting.</p> <p>However, if the connected loads on AC OUT exceed the AC2 breaker setting, the upstream AC breaker trips. The breaker may not trip if <b>Gen Support</b> is enabled and <b>Gen Amps</b> is configured not to exceed the generator's rated output current.</p>
AC2 Lo Volt	Minimum acceptable input voltage level from the generator.
AC2 Hi Volt	Maximum acceptable input voltage level from the generator.
AC2 Lo Freq	Minimum acceptable generator input frequency.
AC2 Hi Freq	Maximum acceptable generator input frequency.

For default settings, see "AC Menu" on page B-4.

---

## Grid Support Settings

The **Grid Support Settings** menu contains configuration options for grid-tie operation. To enable these settings, **Grid Support** must be enabled in the **Setup** menu (see “Conext XW+ Setup Menu” on page 3–2).

In grid support mode, the Conext XW+ supports the utility grid by limiting the power drawn from the utility to close to zero. This mode is desirable for using excess energy from auxiliary DC sources like PV, while still maintaining a charged battery bank. No power is sold to the utility in this mode.

---

**Note:** Grid support and sell functions are modes of operation that are subject to local and/or national grid interconnection requirements in most jurisdictions. It is the responsibility of the installer and system operator to ensure that all applicable procedures and technical requirements are complied with before turning on either of these modes.

---

**Note:** Upon startup, the Conext XW+ does not enable grid support functions for five minutes (300 seconds). During this period the Conext XW+ connects to AC input and determines whether the utility grid voltage and frequency are stable and within nominal range. If **Grid Support** is enabled, the inverter information panel also displays a 300 second countdown during this period. For more information, see “Islanding Protection” on page 1–7.

---

**Note:** In grid support mode, the Conext XW+ should not draw a large amount of current from the grid. If the Conext XW+ is drawing more than expected, it is important to note that it cannot distinguish between real power and reactive power. Large current draw will only affect reactive power and not real power, and utility companies generally only charge by real power consumed.

---

**Table 3-6** Grid Support Settings Menu

Item	Description
Grid Supp Volts	Sets the level to which the batteries will be discharged when the inverter is selling power to the grid or supporting the power grid by providing additional power to the loads on AC Out. This setting is not adjusted for the battery temperature even if the temperature sensor is installed.
Sell	<p>Turns sell mode on and off. When <b>Sell</b> is set to enabled, the Conext XW+ AC output is divided between powering loads and delivering power to the utility grid. Sell mode requires the battery voltage to be above <b>Grid Supp Volts</b>. All configurations must comply with local and national electrical codes. The renewable energy from the battery is exported to the grid as long as the battery voltage is greater than or equal to <b>Grid Supp Volts</b>. See Figure 3-8 on page 3–30.</p> <ul style="list-style-type: none"> <li>• Grid-tie entry condition: battery voltage is greater than <b>Grid Supp Volts</b>.</li> <li>• Grid-tie exit condition: battery voltage is lower than <b>Grid Supp Volts</b> less 0.5 V.</li> </ul> <p>There is a time delay associated with the entry and exit conditions. The default is 20 seconds. The delay can be extended to 40 seconds if the battery voltage is not very stable (Figure 3-3, “Basic and Advanced Settings” on page 3–7 and Table 3-12, “Advanced Features Menu” on page 3–49). This delay helps to avoid sell power fluctuations when the battery voltage fluctuates.</p> <p>There is an exception. The delay is zero when the battery voltage suddenly changes to 2 V above <b>Grid Supp Volts</b>. For example, when a wind turbine or micro-hydro is connected to a small battery bank which may create a sudden change on the battery voltage. In this case the system will immediately respond by converting the energy from the battery to grid.</p>
Max Sell Amps	<p>Sets the maximum AC amps allowed to be delivered to the utility grid from a solar array and/or the batteries during grid-tie operation (except from AC-coupled grid-tied inverter). This setting is only used if <b>Sell</b> is set to enabled.</p> <p><b>Max Sell Amps</b> must be less than 80 percent of the selected AC1 breaker setting. If set higher, the breaker setting will override the <b>Max Sell Amps</b> setting to avoid tripping the breaker.</p>
Load Shave	<p>Enables or disables the load shave feature. Load shave allows the Conext XW+ to support the grid in powering local loads during a defined window of time (set using <b>Load Shave Start</b> and <b>Load Shave Stop</b>). If <b>Load Shave</b> is set to enabled:</p> <ul style="list-style-type: none"> <li>• If the battery voltage is above <b>Grid Supp Volts</b>, then the current taken from the grid is reduced to zero (see Figure 3-7, “Load Shave Mode” on page 3–27). This maximizes the renewable energy for AC load usage.</li> <li>• If battery voltage is below <b>ReCharge Volts</b> +0.5 V, then it will exit load shave mode and enter AC pass through mode.</li> </ul>



**Table 3-6** Grid Support Settings Menu

Item	Description
Load Shave Amps	<p>Sets the maximum amount of current that can be drawn from the AC1 (grid) input by the loads and battery charger combined. This setting determines the amperage level at which the inverter starts drawing power from the batteries to add to the utility power to meet the demand of the loads.</p> <p>Typically, this value is set to the size of the AC circuit breakers feeding the inverter's AC input or the peak usage or time of day surcharge threshold imposed by the utility, if applicable.</p>
Load Shave Start	<p>Sets the time of day that the load shave feature operates. This feature is suited for regions where local utilities impose peak usage or time of day surcharges. The inverter provides load shaving power as long as the battery voltage is 2 V or more above <b>Low Batt Cut Out</b>. See Figure 3-7, "Load Shave Mode" on page 3-27.</p>
Load Shave Stop	<p>Sets the time of day that the load shave feature stops operating. If <b>Load Shave</b> is set to enabled and <b>Load Shave Start</b> and <b>Load Shave Stop</b> are set to the same time, the Conext XW+ load shaves continuously.</p>

For default settings, see "Grid Support Menu" on page B-5.

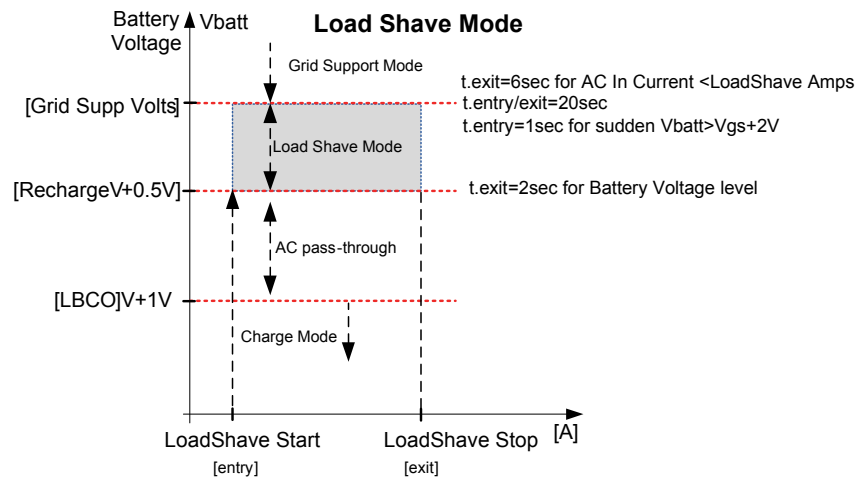

**Figure 3-7** Load Shave Mode

## Prioritizing and Managing Energy Sources with Advanced Features

The Conext XW+ can be programmed to control how and when to use utility power as well as external DC sources of energy such as batteries and solar charge controllers. Advanced features allow management of peak loads, time-of-use billing and self consumption.

### Grid Support

<b>⚠ WARNING</b>
<b>ADVANCED CONFIGURATION HAZARD</b>
Advanced menu settings should be used by qualified personnel only.
Three phase operation should be configured by qualified personnel only.
Consult with the local utility before enabling Conext XW+ sell mode or grid support functions.
Do not change these settings unless you are under the supervision and direction of qualified personnel.
<b>Failure to follow these instructions can result in death or serious injury.</b>

---

**Note:** Grid support and sell functions are modes of operation that are subject to local and/or national grid interconnection requirements in most jurisdictions. It is the responsibility of the installer and system operator to ensure that all applicable procedures and technical requirements are complied with before turning on either of these modes. The interconnect codes and standards with which the Conext XW+ complies are listed in Chapter A, "Specifications".

---

The grid support mode allows the Conext XW+ to support local loads by converting excess capacity from external DC sources connected to its battery bank. Examples of external DC sources are solar charge controllers and batteries.

For grid support to function Grid Support must be enabled on the Setup menu and the battery voltage must be above the **Grid Supp Volts** setting. To export energy to the utility grid (AC1) Conext XW+ sell mode must be enabled.

**Grid Support enabled, Sell disabled** In this mode, available excess DC power is converted and used to power local AC loads attached to the inverter output. No power is exported on AC1 (grid) to the utility. If the local AC load demand exceeds the available power from the external DC sources, power is then drawn from the utility grid (AC1) to support the load. However, if the local AC load demand is less than the power available from external DC sources, the net

excess power from the external DC sources is not converted and hence not used. For optimal sell performance, a battery bank of minimum 440 Ah is recommended.

**Grid Support enabled, Sell enabled** In this mode, all available excess DC power is first used to power local AC loads attached to the inverter output. Any remaining power (up to the Max Sell Amps setting) is exported to the utility grid (AC1). A battery bank rated at least 440 Ah is recommended for best sell performance.

---

**Note:** To comply with anti-islanding requirements specified in UL 1741 for North America in a grid tied AC coupled system, change the AC1 Transfer Delay setting under AC Transfer Configuration to 300 seconds using the Conext Configuration Tool (product number 865-1155-01).

---

**Sell Block** The sell block feature halts the export of energy to the grid connected to AC1 for a period of time each day. This period of time is defined by the Sell Block Start and Sell Block Stop settings. Sell Block can be useful in managing the self consumption of renewable energy.

---

**Note:** Sell block will not block selling from an AC coupled inverter.

---

## Grid Support and Battery Charging

### Charge Cycle settings

With the charger enabled, the Conext XW+ enters grid support mode only after completing a charge cycle when it is first powered up or reconnected to the grid. Set the Conext XW+ Charge Cycle to two-stage (default) to allow grid support to function immediately after the absorption charge stage is completed. See “Charger Settings Menu” on page 3–11.

---

**Note:** Only the Conext XW+ needs to be set to two-stage charging. The Conext Solar Charge Controllers can remain set for three-stage charging. The Conext XW+ should be set in two-stage charging and the charge controllers set in three-stage for solar charging to occur properly. Alternately, charger block can be used to for correct charging. See “Charger Block” on page 3–31 for further information.

---

### Grid Support modes

Grid Support can be configured to operate in one of two modes:

**Grid Support with DC Sources Not Communicating Over Xanbus** This setup is suitable for use with DC sources (such as wind turbines, DC generator sets, fuel cells, and so on) that do not communicate with the Conext XW+ through Xanbus or for mixed systems which have both Xanbus-connected Conext Solar Charge Controllers and other DC sources (such as those listed above).

**Grid Supp Volts** is set 0.5 volts below the voltage provided by the DC source (typically the float voltage setting of the DC source or charge controller). See Figure 3-8, “Grid-tie Sell Mode” on page 3–30. Schneider does not provide support for these energy sources.

In a ‘fixed’ battery voltage system configuration, the Conext XW+ manages the battery voltage to the Grid Supp Volts setting. This is done by converting the available DC power to AC power to support the AC loads attached to the inverter output or exports to the utility grid (AC1). Because the battery bank voltage may

not reach bulk/absorption voltages in this mode, it is recommended to occasionally force a full charge cycle by either temporarily disabling grid support or forcing a bulk charge cycle from the grid (see “Force Chg” on the “Conext XW+ Setup Menu” on page 3–2.)

**Enhanced Grid Support with Conext MPPT Solar Charge Controllers** This setup is suitable for Conext Systems with only Conext MPPT Solar Charge Controller(s) networked to Conext XW+ units through Xanbus. In this configuration, **Grid Supp Volts** is set above the charge controller’s Equalization voltage (for example, 64 volts).

In an enhanced grid support set up the Conext XW+ automatically tracks the Conext MPPT Solar Charge Controller voltage as it transitions through charge states (from bulk to absorption to float). This allows the system to execute a complete battery charge cycle while still converting excess DC power to AC power to support the AC loads or be exported to the utility grid. In doing so, the Conext XW+ only uses excess DC not required by the battery or used to support local AC loads and sells it to the grid, thereby maximizing the use of the PV array. Since this set up allows the battery bank voltage to reach absorption levels (when PV harvest is adequate), the state of health of the battery is improved. The sell entry and regulation voltage level is 1 V below absorption and float of the Conext Solar Charge Controller set points. The exit from sell is 1.5 V below absorption and float of the Conext Solar Charge Controller set points.

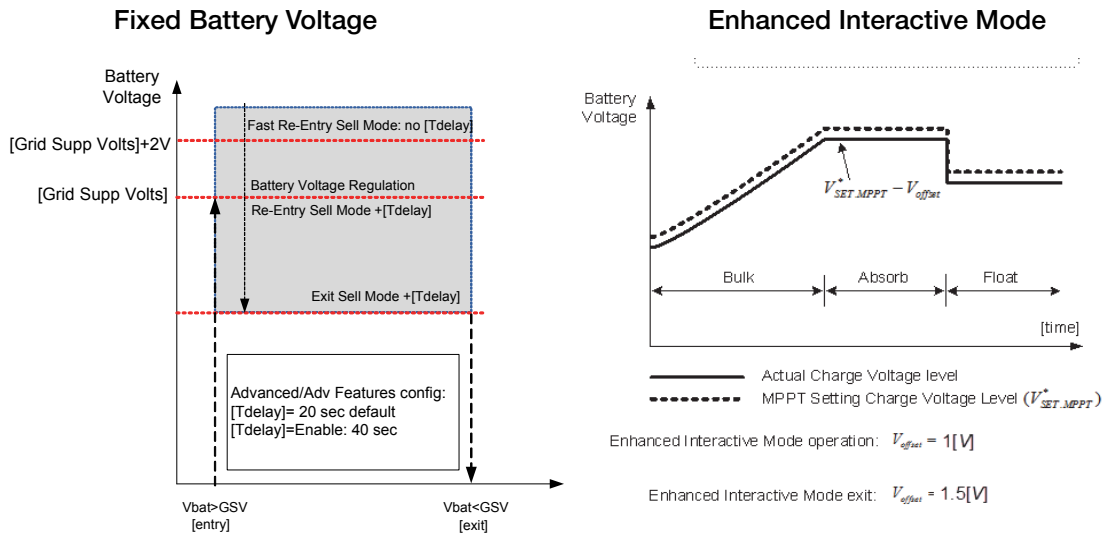

Figure 3-8 Grid-tie Sell Mode

**Note:**

[Tdelay] is an entry/exit transition time delay to/from grid support and sell mode.

If the battery voltage has higher fluctuations due to DC renewable sources (e.g. charge controllers, wind turbines, and so on), then the time delay can be increased by setting **Sell Dly 40s** to enabled (Table 3-12, “Advanced Features Menu” on page 3–49).

If the battery voltage has a sudden increase change greater than **Grid Support Volts + 2 V**, then the Conext XW+ will override the delay and enter grid support or sell mode immediately.

---

## Charger Block

The charger block feature halts charging on AC1 (Grid) for a period of time each day. This period of time is defined by the **Chg Block Start** and **Chg Block Stop** settings. In areas where the utility charges variable rates for electricity, it is preferable to use utility power for charging only during non-peak hours. Charger block can prevent utility power from being used for battery charging during peak billing periods.

During the time period set between **Chg Block Start** and **Chg Block Stop**, AC1 (Grid) input continues to be passed through to the loads. Inverter operation remains unaffected during the charger block period.

During the charger block period, no charging on AC1 occurs even if the batteries discharge below **ReCharge Volts** setting. However, a generator connected to AC2 (in the absence of utility/AC1 power) or a Conext Solar Charge Controller may charge batteries during the charger block period. AC priority must be set to AC2 to charge batteries with a generator connected to AC2 during the charger block period.

If the charger is operating (that is, in float, absorption, bulk, or equalize stage) at the **Chg Block Start** time, charging on AC1 stops immediately and the charger enters an idle state identical to no float (see “Two-Stage” on page 3–16). When the charger block period is over, the charger does not resume the charge stage that was interrupted. Instead, if the batteries are above the **ReCharge Volts** setting, the charger remains idle.

If the battery voltage falls below the **ReCharge Volts** setting during the charger block period, the Conext XW+ begins a new charge cycle with the bulk stage after the charger block period has expired (at the **Chg Block Stop** time).

For example, charger block is set to start at 5:00 PM and end at 8:00 PM. If the Conext XW+ is charging from AC1, charging stops at 5:00. When charger block ends at 8:00, the Conext XW+ does not automatically resume charging. The unit first measures the battery voltage. If the voltage is below the **ReCharge Volts** setting, then the Conext XW+ starts a new charge cycle from bulk. If the battery voltage is above the **ReCharge Volts** setting, the Conext XW+ remains idle and continues passing through AC to the loads. The Conext XW+ also keeps measuring the battery voltage as before to determine whether to start a new charge cycle.

## Peak Load Shaving (PLS)

Many utilities impose a surcharge on their customers based on the peak load used by a facility. To reduce utility peak demand charges, the inverter can be configured (using the **Load Shave Amps** setting) to limit the maximum draw the AC loads place on the utility. The inverter can be programmed to provide power above a specified level to avoid the surcharge. When the utility current draw reaches the maximum level, the inverter assists by sourcing power from the batteries to the loads.

For PLS to be effective, all loads must be connected to the inverter. For large loads, multiple (or stacked) inverters may be required.

To help the batteries supplement the power requirements of the connected load, an additional source of power (solar, wind, or hydroelectric) is recommended.

The default PLS setting for Time in Float is zero. In this case, PLS is only entered/exited as programmed within the time window.

When the Time in Float is different than zero, PLS shall start only if the battery amperage remained at the specified level for the configured time.

**Example: Load Shave=Enabled, LoadShaveAmps=10 A, LoadShaveStart=6:00pm, LoadShaveStop=9:00pm, Time in Float=60 min, PLS Delay 2h= Enabled.**

With these example settings, the Conext XW+ would enter PLS within the configured window of time only if the battery was charged from MPPT in Float (including Absorption) for 2 hours.

## Time-of-Use Metering

Utilities use time-of-use metering to determine utility charges during peak usage hours and to impose a surcharge. The Conext XW+ can be configured (using the **Load Shave Start**, **Load Shave Stop** and **Charger Block** settings) to overcome these peak charges by using utility power to charge the battery bank during the inexpensive energy hours and consuming the battery energy during expensive energy hours.

For example, if **Charger Block** is set between 9:00 AM and 10:00 PM and **Load Shave** is set between 6:00 PM and 9:00 PM, charging on AC1 stops at 9:00 AM and continues to pass utility AC through to the loads. If charging is required during the charger block period, and **AC Priority** is set to AC2, the Conext XW+ can use any AC source connected to AC2. Loads will transfer to the AC source on AC2 as well. The inverter connects to the utility grid at 6:00 PM and supports loads using the batteries. The inverter continues to run until 9:00 PM. The Conext XW+ then stops supporting the utility grid and passes utility AC through to the loads. At 10:00 PM utility AC begins maintaining the batteries based on the battery charger settings.

The above example allows an external renewable energy source to be utilized as a primary charging source during a desired time window. The charger (using utility AC connected to AC1) can then be used to supplement the battery charging when the utility rates are low.

When using the system for time-of-use metering, the system should be designed with a battery capacity large enough to support loads during the entire peak rate period without reaching the **Low Batt Cut Out** setting.

---

**Note:** If the batteries reach the Low Battery Cut Out setting, the Conext XW+ automatically reconnects to the utility grid to maintain the connected load.

---

## Self-Consumption

PLS can also be used with time-of-use metering to support self-consumption. In the self-consumption mode of operation, the Conext XW+ delays Peak Load Shave mode by a fixed time of 2 hours. This is done by allowing a priority for the MPPT solar charge controller to charge the battery bank.

This configuration can be selected under the Conext XW+ menu by selecting **Advanced Settings/Advanced Features/PLS DLY 2H=Enabled**. The default setting for **PLS DLY 2H** is **Disabled**.

## Generator Support Settings

### **⚠ WARNING**

#### **ADVANCED CONFIGURATION HAZARD**

Advanced menu settings should be used by qualified personnel only.

Three phase operation should be configured by qualified personnel only.

Consult with the local utility before enabling Conext XW+ sell mode or grid support functions.

Do not change these settings unless you are under the supervision and direction of qualified personnel.

**Failure to follow these instructions can result in death or serious injury.**

Generator support allows power to be automatically drawn from the batteries to assist an AC generator on AC2 to support heavy loads on AC OUT (loads that exceed the available power from the generator).

Generators have a limited output current and it is possible to reach this limit when operating heavy loads. The Conext XW+ is designed to assist the generator when heavy current demands load down the generator by supplying additional power from the batteries.

In addition, the battery charger can reduce its charging current to the batteries so the combined AC current required for charging and the total load current do not exceed the capacity of the generator or trip its output breakers or fuses.

For imbalanced loads and small generators, the generator support feature may be used. When **GenSupp Plus** is enabled, the Conext XW+ will connect the center of its transformer to the AC2 input neutral to act as a load balancing transformer. This feature will attempt to balance the load between L1 and L2. Generator support is most effective for generators under 5 kW. See Table 3-12, "Advanced Features Menu" on page 3-49.

---

**Note:** The pass through running and startup (peak) currents of generators attached to AC2 are limited to the maximum current limits of the Conext XW+.

---

---

**Note:** If generator support is used with generators larger than 5 kW, it is possible for current to recirculate. In this case, the efficiency losses would outweigh the benefit of generator support.

---



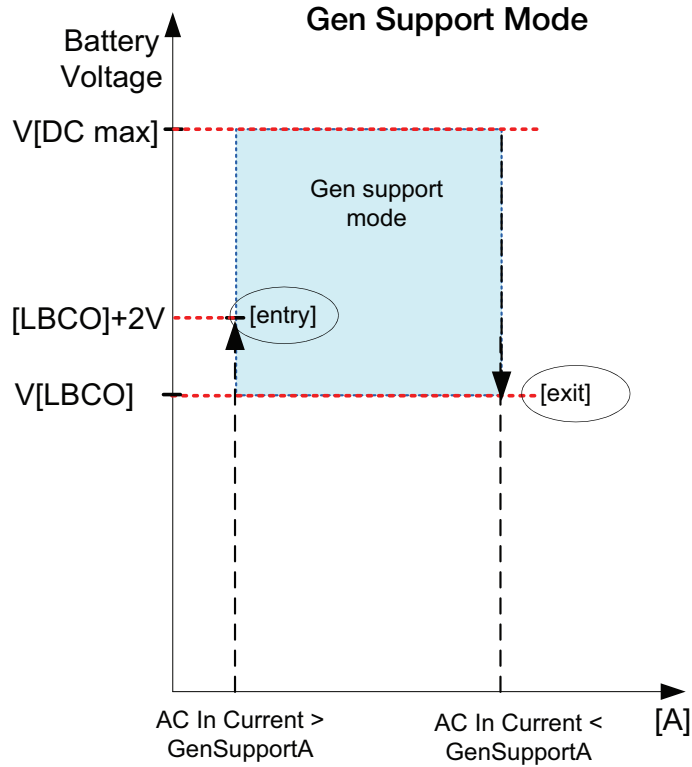

**Figure 3-9** Gen Support Mode Graph

**Note:** Ensure that the battery bank has sufficient energy to support your loads for the anticipated time period, otherwise draining the battery to LBCO may put the system in Fault mode.

**Table 3-7** Gen Support Menu Values

Setting	Description
GenSupp Mode	Turns the generator support feature on and off.
GenSupp Amps	Sets the generator load level at which the Conext XW+ begins to convert external DC energy and supply additional AC power in parallel to loads on AC Out.

For default settings, see “Gen Support Menu” on page B-5.

## Auxiliary Output Settings

### ⚠ WARNING

#### ADVANCED CONFIGURATION HAZARD

Advanced menu settings should be used by qualified personnel only.

Three phase operation should be configured by qualified personnel only.

Consult with the local utility before enabling Conext XW+ sell mode or grid support functions.

Do not change these settings unless you are under the supervision and direction of qualified personnel.

**Failure to follow these instructions can result in death or serious injury.**

The **Aux** menu allows you to enable and set the auxiliary output. The auxiliary output provides 12 volts DC at 250 milliamps to power a relay, indicator light, or alarm.

**Note:** Changing **Trigger Level** resets the auxiliary output. If an auxiliary output trigger is active, changing the trigger level will clear the trigger.

For default settings, see “Aux Menu” on page B-5.

**Table 3-8** Aux Menu Values

Setting	Description
Manual Aux	Sets the state of the auxiliary output. <b>ManualOn</b> or <b>ManualOff</b> allow manual control of the auxiliary output. When set to <b>Automatic</b> , a trigger source can then be selected.
Active Lvl	Sets the mode (polarity) of the auxiliary output. When triggered, the output can be active high (12 VDC output turns on) or active low (output is high until the trigger turns it off).
Trigger Src	Selects the desired condition (trigger source) to activate the auxiliary output. The trigger source options are <b>LowBattV</b> , <b>HighBattV</b> , <b>LowBattTemp</b> , <b>HighBattTemp</b> , and <b>Fault</b> .
Trigger Level	Sets the voltage or temperature level (depending on the selected trigger source) at which the auxiliary output is activated. If the selected <b>Trigger Src</b> is a battery voltage, the range also varies according to the nominal battery voltage of your system.
Trigger Delay	Sets a delay period between when the trigger occurs and when the auxiliary output is activated.
Clear Level	Sets the voltage or temperature level (depending on the selected trigger source) at which the auxiliary output becomes inactive.
Clear Delay	Sets a delay period between when the <b>Clear Level</b> setting occurs and when the auxiliary output becomes inactive.

**Table 3-8** Aux Menu Values

Setting	Description
Charge Bulk Exit	Exits charge bulk mode. In charge bulk mode, the XW operates as a constant power source to the battery bank.
Charge Absorption Exit	Exits charge absorption mode and starts the following mode, depending on whether the unit is set to two or three-stage charge.
Heatsink temperature	Both high and low end within the heatsink temperature range are configurable. The voltage will be adjusted accordingly when the temperature goes out of range (e.g. the voltage is lowered when the temperature gets too high).
State of Charge (SoC)	This feature works only in conjunction with the Conext Battery Monitor. A voltage change is triggered when the state of charge falls outside of the range of 25-90% of total battery charge. When triggered, the output can be active high (12 VDC output turns on) or active low (output is high until the trigger turns it off).
TOD (Time of Day)	Time setting. Can be set to a value between 12:00 AM and 11:59 PM.

#### Trigger Source Descriptions

**Low Batt Voltage** Activates the auxiliary output when the battery voltage falls below **Low Batt Voltage** after the trigger delay time. The auxiliary output turns off when the battery voltage rises above the clear setting after the **Clear Delay** time. Use this setting if the auxiliary output needs to control a relay to disconnect loads from a battery or to activate a low battery voltage alarm such as a buzzer or light.

**High Batt Voltage** Activates the auxiliary output when the battery voltage rises above **Hi Batt Voltage** for the trigger delay time. The auxiliary output turns off when the battery voltage falls below the clear setting for the **Clear Delay** time. This setting is useful for:

- Installations that have another external charging source such as a wind generator or hydro generator connected directly to the batteries. The Conext XW+ auxiliary output can control a relay to disconnect the external charging source from the battery or control a relay to turn on a diversion load.
- Activating a high battery voltage alarm such as a buzzer or light.
- Activating a vent fan to ventilate the battery compartment.

**Low Batt Temp** Activates the auxiliary output when the battery temperature falls below **Low Batt Temp** for the trigger delay time. The auxiliary output turns off when the battery temperature rises above the clear setting for the **Clear Delay** time. Battery temperature is measured with a battery temperature sensor. Do not use this setting if a battery temperature sensor is not installed.

**High Batt Temp** Activates the auxiliary output when the battery temperature rises above **Hi Batt Temp** for the trigger delay time. The auxiliary output turns off when the battery temperature falls below the clear setting for the **Clear Delay**

time. Battery temperature is measured with a battery temperature sensor. Do not use this setting if a battery temperature sensor is not installed. With this setting, the auxiliary output can turn on a fan to vent the battery compartment.

**Fault** Activates the auxiliary output when a fault occurs. The auxiliary output clears when the fault is cleared.

**State of Charge (SoC)** This feature works in conjunction with the Conext Battery Monitor. This auxiliary output is triggered when the state of charge falls outside of the range of 25-90% of total battery charge.

## Multi-Unit Config Menu

### ⚠ WARNING

#### ADVANCED CONFIGURATION HAZARD

Advanced menu settings should be used by qualified personnel only.

Three phase operation should be configured by qualified personnel only.

Consult with the local utility before enabling Conext XW+ sell mode or grid support functions.

Do not change these settings unless you are under the supervision and direction of qualified personnel.

**Failure to follow these instructions can result in death or serious injury.**

The **Multi-Unit Config** menu configures the Conext XW+ to operate as a part of a multi-unit installation.

When installing a multi-unit system, each setting on the **Multi-Unit Config** menu (except for **Dev Name**) must be configured for each Conext XW+ in the system. The settings should be configured in the following order:

- Dev Number
- Inverter Mode
- Connections

**Note:** Accessing this menu automatically places the Conext XW+ in standby mode and de-energizes the circuits on inverter output. When entering the **Multi-Unit Config** menu, the unit identifies itself by flashing the front panel lights. After exiting the **Multi-Unit Config** menu, the Conext XW+ returns to operating mode and the front panel lights stop flashing.

**Table 3-9** Multi-Unit Config Menu

Item	Description	Default	Range
Dev Name	Allows customization of the default device name. This setting is optional and does not affect operation. See "Setting the Device Name" on page 3-41.	n/a	n/a
Dev Number	Allows setting of a unique unit number in a multiple-unit system. See "Setting the Device Number" on page 3-42.	00	00-31

**Table 3-9** Multi-Unit Config Menu

Item	Description	Default	Range
Inverter Mode	<p><b>For a split-phase system:</b> For a multi-unit system to operate, one Conext XW+ must be configured to <b>SplitPhMaster</b> and the rest as <b>SplitPhSlave</b>, otherwise a system-wide fault is asserted.</p>	SplitPhMaster	For single-phase, three-wire models: SplitPhMaster, SplitPhSlave
	<p><b>For a single-phase system:</b> For a multi-unit system to operate, one Conext XW+ must be configured to <b>1PhMaster</b> and the rest as <b>1PhSlave</b>, otherwise a system-wide fault is asserted.</p> <p>Before setting up a single-phase system, perform the steps in “Converting 120 V/240 V Split-Phase to 120 V Single-Phase” in the <i>Conext XW+ Inverter/Charger Installation Guide</i>.</p>	1PhMaster	SplitPhMaster, SplitPhSlave
	<p><b>For a three-phase system:</b> See “Three-Phase Configuration” on page 3–43.</p>		
Connections	Select to display the Connections menu. See “Connections Menu” on page 3–45.	n/a	n/a

---

## Setting the Device Name

The **Dev Name** setting allows you to customize the name of the Conext XW+ as it is displayed on other screens and menus.

The characters available are:

- A to Z
- a to z
- 0 to 9
- space

---

**Note:** Increasing the number of characters in a device name may cause other text on the same line to run off the edge of the screen. Device names should be limited to 10 characters or less.

---

### To customize the Conext XW+ name:

1. On the device setup menu, select **Advanced Settings**.  
If **Basic Settings** appears instead of **Advanced Settings** on the device setup menu, display **Advanced Settings** by pressing Enter + Up arrow + Down arrow at the same time.
2. Select the **Multi-Unit Config** menu.
3. Select **Dev Name**.
4. Press Enter.  
The last letter of the Conext XW+ name is highlighted.
5. Begin customizing the device name.
  - To change the character, press the up or down arrow button. Holding down the button causes the characters to scroll more quickly.
  - To delete the character, press Exit.
  - To add characters, press Enter.
6. When the correct character is shown, press Enter to select it.
7. After pressing Enter to select the last character of your customized device name, press Enter again to return to the menu.

---

**Note:** It is also possible to change the device name using the Conext System Control Panel and the Conext Configuration Tool. Please refer to the respective Owner's Guides of these products for further information.

---

## Setting the Device Number

When several devices of the same type are installed in the Xanbus network, setting the device number is required to give a Xanbus-enabled device a unique identity. When each identical device has a unique number, the Conext SCP can correctly identify and display status information for each device. A device number consists of two digits ranging from 00 (default) to 31.

If only one of each type of device is installed in the networked power system, a device number is not needed. However, setting the device number to a value other than 00 is recommended in case you need to use the **Restore Defaults** command. This command resets the device number to 00. After performing the command, checking that the device number has returned to 00 indicates that the command was successfully completed.

### To set the Conext XW+ device number:

1. On the Conext XW+ Setup menu, select **Advanced Settings**.  
 If **Basic Settings** appears instead of **Advanced Settings** on the **Setup** menu, display **Advanced Settings** by pressing Enter + Up arrow + Down arrow simultaneously.  
 On the **Advanced Settings** menu, select **Multi-Unit Config** and press Enter.
2. On the **Multi-Unit Config** menu, select **Dev Number**. See Figure 3-10.
3. Press Enter to highlight the instance number.
4. Use the up and down arrow buttons to adjust the two-digit identifier number.
5. Press Enter.

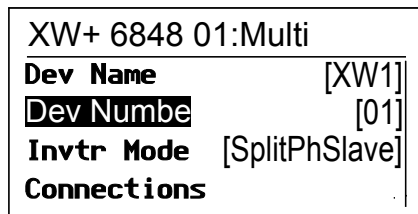

**Figure 3-10** Setting a Device Number



## Three-Phase Configuration

### **⚠ WARNING**

#### **ADVANCED CONFIGURATION HAZARD**

Advanced menu settings should be used by qualified personnel only.

Three phase operation should be configured by qualified personnel only.

Consult with the local utility before enabling Conext XW+ sell mode or grid support functions.

Do not change these settings unless you are under the supervision and direction of qualified personnel.

**Failure to follow these instructions can result in death or serious injury.**

### **NOTICE**

#### **30 KVA GRID SELL LIMITATION**

The Conext XW+ has non-adjustable setpoints for response to abnormal grid frequency and voltage (see “Response to Abnormal Grid Conditions” on page A-4). Do not aggregate Conext XW+ units on a common point of connection to the grid in excess of 30 kVA (per Std IEEE1547: 2003). Consult with a local utility inspector before enabling the Sell feature on the Conext XW+.

**Failure to follow these instructions can result in equipment damage.**

When installed in a three-phase system, the Conext XW+ requires a designated master unit on each phase. If there is not a master unit on each phase, a system-wide fault (F66) is asserted. Before setting up a three-phase system, confirm that the Conext XW+ units have been installed and wired for three-phase. See the *Conext XW+ Inverter/Charger Installation Guide* for further information.

The Conext XW+ is capable of supporting three-phase systems and supports different configurations for grid-tie and off-grid applications. The Conext XW+ will support either three units or six units in a three-phase grouping when deployed as a grid-tie backup system. If energy is to be sold to the grid, the system must be adjusted to so that it does not exceed 30 kW. The power adjustment on each phase must be made at the time of commissioning and under supervision of a utility representative. Off-grid deployment of six or more Conext XW+ units in a single three-phase grouping is not supported.

For off-grid applications, the Conext XW+ is deployed in clusters of three units (one per phase) for three-phase off-grid systems. Up to four clusters can support off-grid using an external AC contactor system for managing the AC bus line

between sources of AC and consumption loads. For the installation, setup and commissioning of multi-cluster systems, refer to the *Off-Grid Systems Guide* for Conext XW+ available at [solar.schneider-electric.com](http://solar.schneider-electric.com).

**Note:** The XanBus communications protocol supports a maximum of twelve Conext XW+ units in a single network.

To set up a three-phase system:

1. Follow the instructions in the *Conext XW+ Inverter/Charger Installation Guide* to Daisy chain XW-phA, XW-phB, and XW-phC at each unit's AC sync port and connect an AC sync cable between the second AC sync port in unit 2 and an AC sync port in unit 3.
2. On the Conext System Control Panel (Conext SCP), select XWabcd 00 > **Advanced Settings** > **Multi-Unit Config** (where abcd is the model number 6848 or 5548).
3. Optionally, change the device name or device number. Device numbers are suggested to facilitate identifying devices on the system as well as phase association from a device's name and number. Naming devices may be customized as desired. Conflicting device names are allowed and will not cause faults in the system, however giving them unique names is highly recommended.
4. Under **Invtr Mode**, select:
  - 3Ph L1Master for unit 1 or Phase A
  - 3Ph L2Master for unit 2 or Phase B
  - 3Ph L3Master for unit 3 or Phase C
5. Optionally, up to one additional Conext XW+ may be installed in parallel on each phase (for grid-tie systems only). Additional units are called "slave units". This configuration allows for a maximum of 6 units in a single grouping. For larger groupings of up to 12 total units, see the *Off-Grid Systems Guide* for Conext XW+ available at [solar.schneider-electric.com](http://solar.schneider-electric.com). The slave unit on each phase (parallel) must be configured as 3PhL1Slave, 3PhL2Slave, and 3PhL3Slave respectively. A maximum of two units per phase is allowed. Under **Invtr Mode**, select:
  - 3Ph L1Slave for unit 4 or Phase A
  - 3Ph L2Slave for unit 2 or Phase B
  - 3Ph L3Slave for unit 3 or Phase C
6. Confirm that the Grid or Gen wiring has the correct A, B, C phase sequence with the three Conext XW+ Inverter/Chargers. If the phase sequence is incorrect, the Conext system will not qualify the input AC voltage.
7. Put the wiring compartment cover back in place, and then power up the converted units. Perform an AC voltage measurement in invert mode. Make sure the output voltage is within 115 – 120 VAC.

**Table 3-10** Example Three-phase Inverter Assignments

Line or Phase	Inverter Mode	Role Assignment <sup>a</sup>	Suggested Device Number
Line-1 or Phase-A	3Ph L1 Master <sup>b</sup>	Phase-A or Line-1 Master	10
	3Ph L1 Slave <sup>c</sup>	Phase-A or Line-1 Slave	11
Line-2 or Phase-B	3Ph L2 Master	Phase-B or Line-2 Master	20
	3Ph L2 Slave	Phase-B or Line-2 Slave	21
Line-3 or Phase-C	3Ph L3 Master	Phase-C or Line-3 Master	30
	3Ph L3 Slave	Phase-C or Line-3 Slave	31

a. Each phase can support one master unit and one slave unit.

b. The L1 Master is also the master Conext XW+ for the entire system. The system master broadcasts phase synchronizing pulses through its sync port, and each phase master controls the slave units on its respective phase.

c. The slave unit in each phase is optional.

## Connections Menu

### **⚠ WARNING**

#### **ADVANCED CONFIGURATION HAZARD**

Advanced menu settings should be used by qualified personnel only.

Three phase operation should be configured by qualified personnel only.

Consult with the local utility before enabling Conext XW+ sell mode or grid support functions.

Do not change these settings unless you are under the supervision and direction of qualified personnel.

**Failure to follow these instructions can result in death or serious injury.**

The **Connections** menu contains additional settings to allow the Conext XW+ to function as part of a multi-unit networked system.

Setting the connections for a Xanbus-enabled device provides a way of identifying non-network associations for Xanbus-enabled devices (see Figure 3-11) and enhancing networked power system management. When connections are set, devices of different types become associated and can share sources, e.g. a common DC input source, or a common grid/generator source.

In multi-unit networked systems, multiple inverter/chargers can be stacked to produce increased charge current. To achieve this functionality, the devices must be configured to the same DC connection, such as House Battery Bank 1. The units will collaborate on battery charging by communicating with other units on this shared DC connection.

**Note:** When configuring clusters of three Conext XW+ units (or a grouping of up to six in a grid-tie application), each cluster's DC connections must be set to the same battery bank. If one of the units is set with a different DC connection, a system configuration fault (F66) occurs.

**Table 3-11** Connections Menu

Item	Description
DConn	DC input and output connection. This is the common DC connection shared between the Conext XW+, charge controllers, and referenced by the Conext Automatic Generator Start.
ACOut	AC output connection. This connection specifies a common AC output connection shared between Conext XW+ units. The AC output connection has to be configured so that the units know if they are connected to the same load or not. If connected to the same load, select the same name on all units; for example, "ACLoad1." If connected to separate load banks, use different names for the AC output connection on each unit; for example, "ACLoad1" on one unit and "ACLoad2" on the other.
AC1	AC1 input connection. This connection specifies a common AC port 1 input for multiple Conext XW+ units.
AC2	AC2 input connection. This connection specifies a common AC port 2 input for multiple Conext XW+ units.

For default settings, see "Connections Menu" on page B-6.

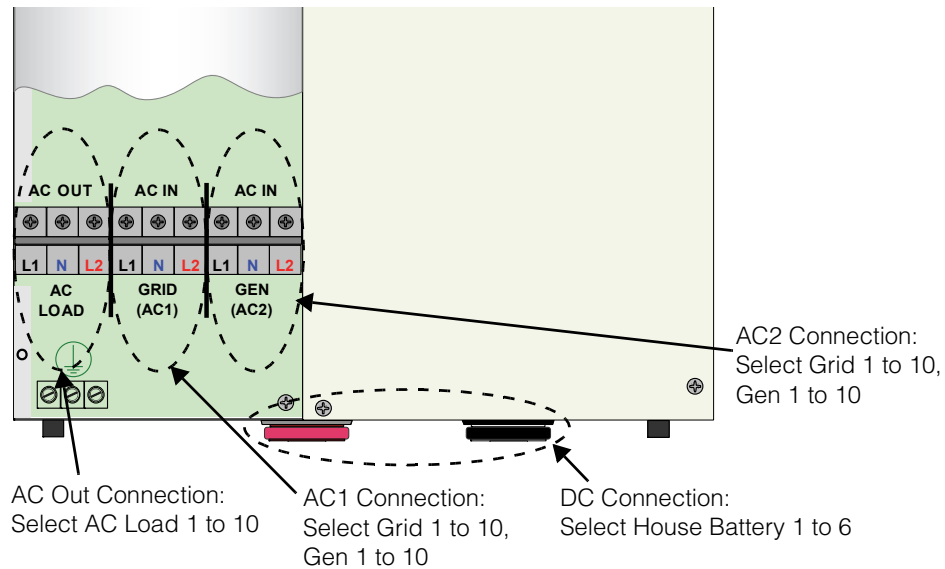

**Figure 3-11** Conext XW+ Connections Representation

---

## Copying Settings From Another Unit

### **▲ WARNING**

#### **ADVANCED CONFIGURATION HAZARD**

Advanced menu settings should be used by qualified personnel only.

Three phase operation should be configured by qualified personnel only.

Consult with the local utility before enabling Conext XW+ sell mode or grid support functions.

Do not change these settings unless you are under the supervision and direction of qualified personnel.

**Failure to follow these instructions can result in death or serious injury.**

The **Copy from** command allows quick configuration of a Conext XW+. After selecting another Conext XW+ in the system to copy settings from, common parameters are copied from the selected Conext XW+ to the Conext XW+ being configured.

The following settings are copied from the selected unit:

- Inverter settings
- Charger settings
- AC settings
- Grid support settings (except the **Sell** setting)
- Gen support settings

The following settings are not copied between units:

- Inverter mode
- Device number
- Device name
- Auxiliary output settings

## Resetting the Conext XW+ to Default Settings

### **▲ WARNING**

#### **ADVANCED CONFIGURATION HAZARD**

Advanced menu settings should be used by qualified personnel only.

Three phase operation should be configured by qualified personnel only.

Consult with the local utility before enabling Conext XW+ sell mode or grid support functions.

Do not change these settings unless you are under the supervision and direction of qualified personnel.

**Failure to follow these instructions can result in death or serious injury.**

The **Restore Defaults** command returns the Conext XW+ to factory default settings. After using the **Restore Defaults** command, the Conext XW+ is no longer configured for the power system.

### **NOTICE**

#### **RESTORING DEFAULTS**

Do not restore defaults while the Conext XW+ is operating. De-energize the power system and disconnect the Conext XW+ AC input before restoring defaults. Reconfigure the Conext XW+ before reconnecting the AC input and re-energizing the power system.

**Failure to follow these instructions can result in equipment damage.**

**To restore Conext XW+ default settings:**

1. On the **Advanced Setup** menu, select **Restore Defaults**.  
Warning W252 appears, asking to confirm the command.
2. To cancel the command, press Exit. To continue with the **Restore Defaults** command, press Enter.

---

**Note:** If a warning is already active in the system, selecting **Restore Defaults** brings up the **Warnings** list, with warning W252 at the top. Press Enter to view W252 and continue with the restore defaults process.

---

## Using the Advanced Features

### **▲ WARNING**

#### **ADVANCED CONFIGURATION HAZARD**

Advanced menu settings should be used by qualified personnel only.

Three phase operation should be configured by qualified personnel only.

Consult with the local utility before enabling Conext XW+ sell mode or grid support functions.

Do not change these settings unless you are under the supervision and direction of qualified personnel.

**Failure to follow these instructions can result in death or serious injury.**

**Table 3-12** Advanced Features Menu

<b>Item</b>	<b>Description</b>
RPO	Enables or disables the remote power off function. Enable this setting if an external switch has been connected to the Conext XW+ auxiliary port. See the <i>Conext XW+ Inverter/Charger Installation Guide</i> for more information about the auxiliary port.
Power Save	When enabled, power save mode can reduce tare loss from the battery by reducing output from 240 volts to 220 volts when the loads are less than 100 watts. When the Conext XW+ detects loads higher than 100 watts, it produces the full 240 volts. Power Save mode is disabled by default.
Sell Dly 40s	When enabled—and other conditions are satisfied—there will be a 40 second delay before the system starts exporting energy to the grid. When disabled, the default value of 20 seconds is used. This feature is useful when the battery voltage is not constant. It also helps avoid power fluctuations during sell.  As an exception, there will be zero time delay when the battery voltage suddenly rises to 2 V above <b>Grid Supp Volts</b> . For example, a wind turbine or micro hydro connected to a small battery bank may create a sudden change on the battery voltage. In this case the system will immediately respond to convert the energy from the battery to grid.
AC_Coupling	AC Coupling function is enabled by default (Advanced Features Menu) and should remain enabled except in cases where the DC voltage level is allowed to have large variations and the AC line frequency needs to remain constant.

**Table 3-12** Advanced Features Menu

Item	Description
Batt_Balance	The Battery Balance function is disabled by default and is intended for use with inverters drawing power from a single battery bank. The Battery Balance function should be enabled when Conext XW+ units are used in multi-cluster systems with multiple battery banks. When enabled this feature helps balance the power draw across multiple battery banks.
EXT_CONTACT	This feature is used in a multi-cluster configuration with external contactor for off-grid applications. Further details regarding the use of an external contactor can be found in the <i>Conext Multi-Cluster Planning Guide</i> (document part number: 975-0648-01-01).
PLS DLY 2h	When enabled, PLS (Peak Load Shave) mode is delayed by 2 hours to allow the MPPT solar charge controller to charge the battery bank first, then when the timer of 2 hours expires, the unit enters PLS mode for AC load support.
TOV_DISCNCT	<p>The TOV (Transient Over-voltage) disconnect feature is used for utility interconnect requirements (e.g. HECO - Hawaii Electric company, Tariff Rule 14H - Supplemental requirement - Transient Over-voltage fast trip).</p> <p>While in sell mode, the Conext XW+ will disconnect within one line cycle when the grid voltage is above 120% of its nominal value.</p>



# 4

## Troubleshooting

Chapter 4, “Troubleshooting”, contains information and procedures for identifying and solving possible problems with the Conext XW+ Inverter/Charger.

Topics in this chapter include:

- “General Troubleshooting Guidelines” on page 4–2
- “Inverter Applications” on page 4–3
- “Inverter Troubleshooting” on page 4–4
- “Battery Charger Troubleshooting” on page 4–7
- “Faults and Warnings” on page 4–10

## General Troubleshooting Guidelines

This section will help you narrow down the source of any problem you may encounter. Please read the following troubleshooting steps:

1. Check for a Warning or Fault message on the Conext System Control Panel or a Fault code on the inverter information panel. If a message is displayed, record it immediately.
2. As soon as possible, create a detailed record of the conditions at the time the problem occurred. These details should include, but not be limited to, the following:
  - Loads the Conext XW+ was running or attempting to run.
  - Battery condition at the time of failure (for example battery voltage or temperature) if known.
  - Recent sequence of events (for example, charging had just finished, utility grid had failed but the inverter did not start up).
  - Any known unusual AC input factors such as low voltage or unstable generator output.
  - Extreme conditions which may have existed at the time (for example, temperature or moisture).
3. Attempt the solution corresponding to the Warning or Fault message in Table 4-3 on page 4-12 or Table 4-6 on page 4-19.
4. If your inverter information panel or Conext SCP is not displaying a Fault light, check the following list to make sure that the present state of the installation allows proper operation of the unit. See also “Inverter Troubleshooting” on page 4-4 and “Battery Charger Troubleshooting” on page 4-7.
  - Is the Conext XW+ located in a clean, dry, adequately ventilated area?
  - Have the AC input breakers opened? If so, your pass through load may have exceeded the rating of one or more of the input breakers.
  - Are the battery cables adequately sized and short enough? See the Conext XW+ *Installation Guide* for more information.
  - Is the battery in good condition and are all DC connections tight?
  - Are the AC input and output connections and wiring in good condition?
  - Are the configuration settings correct for your particular installation?
  - Are the display panel and the communications cable properly connected and undamaged?
  - Are the battery temperature sensor and its cable properly connected and undamaged?
5. Contact Customer Service for further assistance. Please be prepared to describe details of your system installation and provide the model and serial number of the unit. See page ii for contact information.

## Inverter Applications

The Conext XW+ performs differently depending on the AC loads connected to it. If you are having problems with any of your loads, read this section.

### Resistive Loads

Resistive loads are the easiest and most efficient to drive. Voltage and current are in phase, which means they are in step with one another. Resistive loads generate heat in order to accomplish their tasks. Toasters, coffee pots, and incandescent lights are typical resistive loads. It is usually impractical to run larger resistive loads—such as electric stoves and water heaters—from an inverter due to their high current requirements. Even though the inverter may be able to accommodate the load, the size of battery bank will limit inverter run time.

### Motor Loads

Induction motors (AC motors without brushes) require up to six times their running current on startup. The most demanding are those that start under load (for example, compressors and pumps). Of the capacitor start motors (typical in tools such as drill presses and band saws), the largest you can expect to run is 1 horsepower. Universal motors are generally easier to start. Check that the Locked Rotor Amps (LRA) rating of the motor load does not exceed the maximum surge current rating of the inverter. Since motor characteristics vary, only testing will determine whether a specific load can be started and how long it can be run.

If a motor fails to start within a few seconds or loses power after running for a time, it should be turned off. When the inverter attempts to start a load that is greater than it can handle, the inverter may shut down from an AC overload fault.

### Problem Loads

#### Very Small Loads

If the power consumed by a device is less than the threshold of the search mode circuitry, and search mode is enabled, the inverter will not run. Most likely the solution will be to disable **Search** mode or lower the sense threshold. (See “Using Search Mode” on page 3–9.)

#### Fluorescent Lights and Power Supplies

Some devices cannot be detected when scanned by search mode circuitry. Small fluorescent lights are the most common example. Some computers and sophisticated electronics have power supplies that do not present a load until line voltage is available. When this occurs, each unit waits for the other to begin. To drive these loads, either a small companion load like a light bulb rated for more than the **Search Watts** setting must be used to bring the inverter out of search mode, or the inverter may be programmed to remain on by disabling search mode (See “Using Search Mode” on page 3–9).

## Clocks

You may notice that your clocks are not accurate. Some of the clocks on your appliances may reset when the Conext XW+ is in search mode. Disabling search mode will resolve this issue (See “Using Search Mode” on page 3–9).

## Searching

When the inverter is in search mode, it may fail to start some loads even though the rated wattage on the load is more than the **Search Watts** setting. Disable search or apply an additional load (companion load) to make the inverter exit search mode.

## Inverter Troubleshooting

To determine the cause of an inverter error condition, refer to the troubleshooting table below for possible solutions.

**Table 4-1** Troubleshooting Common Problems

Problem	Possible cause	Solution(s)
Unit will not power on (no LEDs are on) and the inverter information panel is blank or off.	Unit was turned off using STARTUP/ SHUTDOWN button on front panel.	Turn the unit on again.
	DC voltage on the inverter's DC terminals is incorrect.	Check the battery voltage, fuses or breakers and DC cable connections to the inverter. If the DC voltage on the inverter's DC terminals is correct, have unit serviced.
Unit goes into invert mode and starts producing AC output, but stops quickly (several attempts made).	Excessive load on output.	Reduce loads.
	Unit is in over-temperature protection and needs to cool down.	Stop inverting by putting the inverter into Standby mode, and then allow the unit to cool and increase ventilation. If necessary, replace the foam air filter on the bottom of the unit.
	Remote Power Off signal is present.	Release or reset the Remote Power Off switch.

Problem	Possible cause	Solution(s)
<p>No AC power output.</p> <p>The inverter information panel displays <i>5ch</i>.</p>	<p>Open AC output breakers or fuses and bad output wire connections.</p> <p>Inverter is disabled. Re-enable inverter.</p>	<p>Check the Load AC Voltage status on the SCP <b>Meters</b> screen and check AC voltage on the inverter AC Out terminal block.</p> <p>If the <b>Meters</b> screen shows correct AC voltage but there is no AC voltage on the inverter AC Out terminal block, check for loose connections on the inverter terminal block. If connections are not loose, the inverter may need to be serviced.</p> <p>If there is correct AC voltage on the <b>Meters</b> screen and on the inverter AC terminal block, check for open AC output breakers or fuses and bad output wire connections.</p> <p>If AC voltage on the <b>Meters</b> screen or inverter AC terminal block is incorrect, have unit serviced.</p>
<p>No AC power output.</p> <p>INVERT LED is flashing.</p>	<p>AC load too small for search mode circuit to detect.</p>	<p>Reduce <b>Search Watts</b> setting, increase load above <b>Search Watts</b> setting, or disable <b>Search</b> on the <b>Setup</b> menu.</p> <p>If the AC1 LED is on, check inverter output connections and voltage.</p>
<p>Low AC power output or low surge power.</p> <p>INVERT LED is on.</p> <p>AC inductive loads are not running at full speed.</p>	<p>Insufficient DC current being provided to the inverter to operate the AC loads.</p>	<p>Check the battery voltage, fuses or breakers and cable connections.</p> <p>Make sure the battery bank is sufficient (check for low DC voltage while running the load).</p> <p>Make sure the cable length and size is correct (see the Conext XW+ <i>Installation Guide</i> for correct cable). Tie the battery cables together to reduce inductance.</p> <p>Apply a load greater than 100 W or disable <b>Power Save</b> (see Table 3-12, “Advanced Features Menu” on page 3-49).</p>

Problem	Possible cause	Solution(s)
<p>Inverter goes into invert mode and starts producing AC output and then stops or does not start at all.</p>	<p><b>Search Watts</b> setting is too low or high.</p> <p>Potential problem loads for search mode:</p> <ul style="list-style-type: none"> <li>• <b>Incandescent lights</b> have a higher starting wattage when the filament is cold than the continuous rating of the bulb.</li> <li>• <b>Fluorescent bulbs</b> draw little power until the mercury vapor begins to conduct enough current to light the tube.</li> <li>• <b>Other loads:</b> Some appliances draw power even when turned off: TVs with instant-on circuits and VCRs, for example.</li> </ul>	<p>If the search sensitivity is set higher than the combined loads, then connect an auxiliary load to bring the inverter out of search mode before the appliances can be turned on.</p> <p>If the sensitivity is set lower than the combination of the loads, the loads will remain on and excess battery drain will occur since the inverter won't ever idle.</p> <p>Another solution is to turn the item off at the wall, use an extension cord with a rocker switch, a switch at the outlet, or an appropriate circuit breaker.</p>
<p>The utility grid is not dropping out, but the unit is disconnecting from the grid.</p>	<p>The AC voltage or frequency provided to the inverter input is outside the AC Setting voltage or frequency range.</p>	<p>Adjust the AC1 voltage and frequency settings (see "AC Input Settings" on page 3–23). Raise the high voltage and frequency settings, and lower the low voltage and frequency settings. If Grid support is enabled, these limits are overridden by the default anti-islanding AC parameters.</p>
<p>The inverter connects to the grid and can charge normally. In a grid interactive mode (<b>Grid Support</b> enabled), the unit is experiencing excessive anti-islanding faults during periods of high sell amperage.</p>	<p>The impedance of the AC connection to the inverter is too high for the power being sold to the grid. The impedance may be on the high end if the installation is too far from the utility point of common connection or if the wires are too small between the Conext XW+ and the main service panel.</p>	<p>Measure the grid voltage at the service panel (meter base). It is important to measure L1-N, L2-N, L1-L2, and N-Ground. If these measurements are not within the voltage range for sell mode (see Table A-1 on page A–2), contact your utility for resolution. If these measurements are within the voltage range for sell mode (see Table A-1 on page A–2), the most likely event is that the AC wiring between the inverter and the meter base is not sized appropriately. It should be sized for a 1 to 1.5% maximum voltage drop. Alternately, the <b>Max Sell Amps</b> can be reduced until the unit stops disconnecting.</p>

## Battery Charger Troubleshooting

To determine the cause of a charger error condition, refer to the troubleshooting solutions below to resolve the situation.

Problem	Possible Cause	Solution
AC1/AC2 LED is on, but will not start charging (allow 40 seconds to synchronize).	<p>1) Charger is disabled on the <b>Setup</b> menu.</p> <p>2) <b>Charger Block</b> is enabled and the Conext XW+ is inside of the charger block time window.</p> <p>3) The Conext XW+ is load shaving.</p> <p>4) Charger is set for 2-stage charging and has completed a full charge cycle.</p> <p>5) Battery voltage is below 40 V and AC source could not be qualified.</p> <p>6) Gen support is enabled and the draw from the loads exceeds the Gen support amps setting.</p>	<p>1) Enable the charger.</p> <p>2) Disable <b>Charger Block</b> if you need to override this feature.</p> <p>3) Check the load shave settings. If the load draw from the grid exceeds <b>Load Shave Amps</b>, the charger will not operate.</p> <p>4) No action required. The charger comes on when the battery reaches the <b>ReCharge Volts</b> setting. Otherwise use the <b>Force Chg</b> setting on the device setup menu to force a bulk or float charge.</p> <p>5) Recharge the batteries with an external battery charger or replace the batteries.</p> <p>6) Temporarily disable Gen support mode, or reduce loads below Gen Support Amps setting.</p>

Problem	Possible Cause	Solution
<p>AC1 or AC2 LED is flashing, but will not start charging</p> <p>(allow 40 seconds to synchronize).</p>	<p>AC voltage and frequency at the AC input terminal are within nominal range, but the inverter output is not yet synchronized to the AC source. There are four possible causes:</p> <p>1) The inverter may already be synchronized to another AC source.</p> <p>2) The AC voltage or frequency applied to the input is outside of the acceptable range of the inverter.</p> <p>3) AC voltage and frequency at the AC input terminals are within acceptable range, but the inverter is not yet synchronized to the AC source.</p> <p>4) A split phase unit may be connected to two legs of three-phase service.</p>	<p>1) The inverter is operating normally.</p> <p>2) Adjust the AC acceptance settings (see “AC Input Settings” on page 3–23) or possibly service an unstable generator.</p> <p>3) For 120 V/240 V units, measure voltage in four places on the input of the inverter: L1-N, L2-N, L1-L2, and N-Ground. These readings must be approximately 120, 120, 240, and 0 respectively. Make sure these readings are within the tolerance for AC acceptance and are stable for at least 60 seconds. See Table 3-5 on page 3–23.</p> <p>4) Connect the split phase unit to split phase power; use an isolation transformer to create a separately derived neutral; or acquire three or six units, convert them to single phase, and then connect a three-phase system to the three-phase source.</p>



Problem	Possible Cause	Solution
<p>Charger amperage drops off before full charging has finished (no Fault LED).</p>	<p>AC frequency at the AC input terminal may be out-of-tolerance (too high or low) or the AC voltage may be outside the <b>Hi AC Volt</b> or <b>Lo AC Volt</b> settings. AC input voltage approaching the low disconnect level.</p> <p>The charge settings are incorrectly configured for your battery type.</p> <p>Ambient temperature may be high, causing unit to overheat and ramp down the charging.</p> <p>Battery bank has one or more bad cells or inadequate wiring.</p> <p>Battery Management System on Lithium Ion battery has interrupted charging.</p>	<p>Check the settings on the <b>AC Settings</b> menu. Check for the correct AC voltage or frequency at the AC input terminal. If the AC source is a generator, adjust the AC voltage or frequency accordingly.</p> <p>Increase the difference between the <b>Hi AC Volt (AC1)</b> and <b>Lo AC Volt (AC1)</b> settings to allow synchronization.</p> <p>Select the correct battery type or configure a <b>Custom</b> battery type.</p> <p>Cool the unit down or check for anything preventing air flow around the unit.</p> <p>Check tightness of battery connections and interconnections. Replace battery.</p> <p>Consult with battery manufacturer for battery compatibility.</p>
<p>Charger stops before full charging (or equalization) has finished.</p> <p>Fault LED flashes and AC output drops momentarily.</p>	<p>Cold temperature around batteries with battery temperature sensor (BTS) installed may be causing unit to reach <b>High Batt Cut Out</b> setting.</p>	<p>Disconnect BTS during charging or increase <b>High Batt Cut Out</b> setting.</p>

Problem	Possible Cause	Solution
Charger output is low.	<p data-bbox="444 287 906 352">Loose or corroded battery connections.</p> <p data-bbox="444 443 906 474">Loose AC input connections.</p> <p data-bbox="444 604 906 636">Worn out batteries.</p> <p data-bbox="444 726 906 758">Battery cables too small or too long.</p>	<p data-bbox="915 287 1373 319">Check and clean all connections.</p> <p data-bbox="915 443 1373 508">Check and tighten AC wiring connections.</p> <p data-bbox="915 604 1373 636">Replace batteries.</p> <p data-bbox="915 726 1373 821">Refer to cable and battery recommendations in the <i>Conext XW+ Installation Guide</i>.</p>
Batteries being charged above the bulk/float settings.	<p data-bbox="444 848 906 934">If a BTS (Battery Temperature Sensor) is installed, it may be in a cold area or have fallen off the batteries.</p> <p data-bbox="444 1045 906 1110">Another DC charging source may be on the batteries.</p> <p data-bbox="444 1134 906 1199">Battery bank size too small relative to charger output.</p>	<p data-bbox="915 848 1373 934">Inspect the BTS. Reduce <b>Batt Temp Comp</b> on <b>Custom Battery Settings</b> menu.</p> <p data-bbox="915 1134 1373 1199">Increase battery bank size or decrease max charge rate.</p> <p data-bbox="915 1222 1373 1404"><b>Note:</b> To bring batteries that are cold to the correct state of charge may require charging at a higher voltage. This may be normal BTS operation. Unplug the BTS and determine if your voltage returns to the bulk/float voltage.</p>

## Faults and Warnings

When a fault or warning message appears on the Conext SCP, you can acknowledge the message to clear the screen. To acknowledge a fault or warning message, press the Enter button. This action does not clear the fault or warning condition - consult Table 4-3 and Table 4-6 for suggested actions after you have acknowledged the message. Refer to the *Conext System Control Panel Owner's Guide* for more information on faults and warnings.

## Warning Messages

Warning messages appear on the Conext SCP to alert you to an impending system change. You can view the 20 most recent warning messages using the Conext SCP's warning log, accessible from the **View Device Info** menu. Each warning has a time stamp to let you know the date and time that the warning appeared.

If several warning messages occur before you can acknowledge or clear them, they are displayed together on a warning list. This list contains messages from every Xanbus-enabled device, not just the Conext XW+. You can select a message and view its details from warning list.

### To view a message from a warning list:

1. On the list, use the up arrow or down arrow button to highlight the message you want to view.
2. Press Enter. The complete message appears.

After viewing the message, you can return to the warning list by pressing Exit or continue to the menu for the device that caused the warning by pressing Enter. Each time you return to the list after viewing a complete message, the viewed message is removed from the list.

If you have left the warning list, you can view warnings at any time from the **System Settings** menu.

### To view a warning list:

1. On the **Select Device** menu, highlight **System** and press Enter.
2. On the **System Settings** menu, highlight **View Warning List**.
3. Press Enter.

## Warning Types

There are two types of warnings: automatic and manual. When the Conext XW+ detects a warning condition, it displays a warning message on the Conext SCP. Table 4-2 describes how their behavior differs and how you can respond to them when they appear on the Conext SCP.

**Table 4-2** Warning Types and Behavior

Warning type	Behavior
Automatic warning	Clear automatically if the warning condition that generated the message goes away. You can also acknowledge automatic warnings without waiting for them to clear automatically.

**Table 4-2** Warning Types and Behavior

Warning type	Behavior
Manual warning	<p>Require you to acknowledge them before you can proceed with configuring or operating the Conext XW+. Manual warnings are usually in the form of a Yes/No question that you may acknowledge by pressing the Enter button on the Conext SCP for Yes and the Exit button for No.</p> <p>Refer to the <i>Conext System Control Panel Owner's Guide</i> for more information.</p>

Table 4-3 provides descriptions of the warning messages and solutions.

**Table 4-3** Warning Messages

Warning Number	Conext System Control Panel Message	Warning Type	Cause	Solution
W44	Battery Over Temperature	Automatic	Battery Over Temperature Warning. Battery temperature is over 50 °C (122 °F).	Check battery voltage and battery cable connections. Stop charging, if necessary. Check for excessive ambient temperature and adequate ventilation in the battery compartment
W45	Capacitor over temperature	Automatic	DC Bulk Capacitor over temperature (100 °C/ 212 °F)	Ensure adequate ventilation around the Conext XW+. Reduce the AC loads.
W48	DC Under Voltage	Automatic	Battery voltage is below 47 V.	Check for the correct battery voltage at the inverter's DC input terminals. Check for an external DC load on the batteries. Check condition of batteries and recharge if possible or reduce your Low Batt Cut Out setting.
W49	DC Over Voltage	Automatic	Battery voltage is above 68 V.	<p>Turn off or check additional charging sources to batteries. Check battery cables.</p> <p>Check for the correct battery voltage at the inverter's DC input terminals. Ensure your DC source is regulated below your high battery cut out or increase your <b>High Batt Cut Out</b> setting.</p>

**Table 4-3** Warning Messages

Warning Number	Conext System Control Panel Message	Warning Type	Cause	Solution
W57	FET1 Over Temperature	Automatic	<p>Internal temperature is over 85 °C (185 °F).</p> <p>AC input voltage may be too high while charging.</p> <p>Operating too large of a load for too long while inverting.</p> <p>Ambient temperature may be high.</p> <p>Inverter cooling fan may have failed.</p> <p>Inverter airflow intake may be blocked.</p> <p>Charging setting is too high based on ambient temperature around inverter.</p>	<p>Check for high input AC voltage.</p> <p>Remove excessive loads.</p> <p>Let inverter cool down and try restarting.</p> <p>Hold a piece of paper to inverter vents to check the fan. If the fan has failed, have the inverter serviced.</p> <p>Increase clearance around the inverter or unclog the fan air intake.</p> <p>Lower the Max Charge Rate setting.</p>
W58	FET2 Over Temperature	Automatic	See W57.	See W57.
W63	AC Overload	Automatic	Excessive load on the AC output.	Check for loads above the inverter's capacity. Turn off some loads if necessary.
W64	AC Overload	Automatic	See W63.	See W63.
W68	Transformer Over Temperature	Automatic	See W57.	See W57.

**Table 4-3** Warning Messages

Warning Number	Conext System Control Panel Message	Warning Type	Cause	Solution
W70	Synchronization Warning	Manual, AC input is not qualified	<p>1. An AC input voltage phase is lost or out of the AC range in the three-phase.</p> <p>2. AC input voltage phases are not synchronized with Conext 3-phase system.</p>	<p>1. Check the AC voltage presence of each phase at the AC input terminals for each Conext XW+.</p> <p>2. Inspect the three-phase wiring to have the correct phase sequence: XW-Phase-A, XW-Phase-B, XW-Phase-C with the same AC input sequence to each unit.</p>
W94	Remote Power Off	Automatic	The unit has been turned off with a Remote Power Off switch.	No action required. The unit stops inverting or charging immediately, and shuts down after five seconds. If the unit is configured as a master, it signals other network devices to also shut down.
W95	Equalize Abort	Manual	Equalization terminated abnormally because of interrupted AC input.	Wait until AC input (utility grid) returns to in-tolerance condition.
W96	Cannot Equalize	Manual	<p>The selected battery type should not be equalized.</p> <p>AC input is not qualified or the charge setting is not adequate.</p>	<p>Change battery type if your batteries should be equalized. Gel or AGM batteries should not be equalized.</p> <p>Check for presence of AC. Make sure <b>Charge</b> and <b>Equalize</b> are enabled. Verify the Conext AGS trigger is set to <b>Stop Float</b>. If <b>Stop V</b> is enabled, then the voltage level should be above the <b>Eq1z Voltage</b> level.</p>
W97	Battery temperature sensor failure	Automatic	Battery Temperature Sensor Shorted	Replace battery temperature sensor.
W500	Lost network connection	Automatic	Lost network connection	Check network cables.

**Table 4-3** Warning Messages

Warning Number	Conext System Control Panel Message	Warning Type	Cause	Solution
W501	Inv/Chg is trying to fix a memory problem	Manual	Non-volatile memory warning	Normal operation may return or may go to fault. Turn Conext XW+ off and on to resume normal operation.

## Fault Messages

When the Conext XW+ detects a fault condition, the fault is displayed on the Conext System Control Panel. The Conext XW+ also illuminates the Fault light on the Conext System Control Panel and inverter information panel. A fault affects the operation of the unit. See “Fault Types” on page 4–17 for an explanation of the different fault types.

You can view the 20 most recent fault messages on the Conext System Control Panel by selecting Fault Log from the Device Info menu in the Conext XW+ Setup Menu.

If several faults occur before you can acknowledge or clear them, they are displayed together on a fault list. This list contains messages from every Xanbus-enabled device, not just the Conext XW+. You can select a message and view its details from the fault list.

### **To view a message from a fault list:**

1. On the list, use the up arrow or down arrow button to highlight the message you want to view.
2. Press Enter. The complete message appears.

After viewing the message, you can return to the fault list by pressing Exit or continue to the menu for the device that caused the fault by pressing Enter. Each time you return to the list after viewing a complete message, the viewed message is removed from the list.

If you have left the fault list, you can view faults at any time from the System Settings menu.

### **To view a fault list:**

1. On the Select Device menu, highlight System Settings and press Enter.
2. On the System Settings menu, highlight View Fault List and press Enter.



## Fault Types

There are three types of fault messages: automatic faults, manual faults, and escalating automatic faults. Table 4-4 describes how they differ in their behavior and how you can respond to them when they appear on the Conext System Control Panel.

**Table 4-4** Fault Types and Behaviors

Fault type	Behavior
Automatic faults	Clear automatically if the fault condition that generated the message goes away. You can also acknowledge automatic faults without waiting for them to clear automatically. It is not possible to clear a fault if the cause of the fault is still present.
Manual faults	Require you to clear them by: <ul style="list-style-type: none"> <li>• selecting Clear Faults on the Main Conext XW+ menu or on the menu for the Xanbus-enabled device that generated the fault (if the fault condition still exists, the fault message reappears).</li> <li>• correcting the condition that caused the fault.</li> </ul>
Escalating automatic faults	Clear automatically if the fault condition goes away, just like an automatic fault.  However, if an escalating automatic fault occurs several times within a defined time period, the escalating automatic fault becomes a manual fault, requiring user intervention. For example, if an AC Overload fault occurs three times in five minutes, it will no longer clear itself and become a manual fault. Then you must identify the problem, correct the fault condition, and clear the fault.

## Inverter Operation After Faults

Conext XW+ operation changes when a fault occurs. How the operation changes depends on the operating state of the unit when the fault occurred—inverting, charging, grid or generator support, AC bypass, and so on—and on which fault has occurred.

**Table 4-5** Inverter Operation After Faults

Faults	State when Faults Occur	Action After Faults
F1, F2: AC Output	Inverting	Unit stops inverting and waits for nominal AC output voltage level, or a manual clear from user.
F17 to F22: Relay Welded	Inverting	Unit stops inverting and waits for user to clear fault.

**Table 4-5** Inverter Operation After Faults

<b>Faults</b>	<b>State when Faults Occur</b>	<b>Action After Faults</b>
F23 to F40: Anti-Islanding	Grid Support (Peak Load Shaving or Selling)	Unit moves to AC bypass and waits for nominal grid conditions to return for a minimum of five minutes.
F41, F42: Aux power supply voltage	Unit has qualified AC input.	Unit shuts down and waits for nominal AC output voltage level, or a manual clear from user.
F44: Battery Over Temp  F45: Capacitor Over Temp	Any state.	If inverting, the unit shuts down and waits for the temperature to return to nominal value. If in any of the AC-interactive states (charging, peak load shaving, sell, gen support), the unit goes into AC bypass mode until the temperature returns to the nominal value. If the unit is not in AC bypass, it shuts down until the temperature returns to nominal value. After these faults clear, the unit returns to its previous operating state.
F47 to F49: DC Under Voltage and Over Voltage	Unit is inverting or has qualified AC input and is preparing to charge.	If inverting, the unit shuts down and waits for nominal voltage. If operating with a qualified AC source, the unit charges if charging is enabled, or remains in AC bypass if charging is disabled.
F63 to F65: AC Overload	Inverting or Grid Support	Unit stops inverting and waits to qualify AC. Unit waits for user to manually clear fault.

Table 4-6 provides descriptions of the fault messages and solutions. If you are unable to resolve the problem after referring to this table, contact your dealer or Customer Service.

**Table 4-6** Fault Messages

<b>Fault Number</b>	<b>Message</b>	<b>Fault Type</b>	<b>Cause</b>	<b>Solution</b>
F1	AC Output Under Voltage	Escalating Auto Fault. Must occur 3 times in 2 minutes before becoming a manual fault.	AC under voltage shutdown at 108 V. The inverter has shut down to protect the loads.	Clear the fault and attempt restart. If problem persists, call customer service.
F2	AC Output Over Voltage	Escalating Auto Fault. Must occur 3 times in 30 seconds before becoming a manual fault.	AC over voltage shutdown at 135 V. The inverter has shut down to protect the loads.	Clear the fault and attempt restart. If problem persists, call customer service.
F17	Relay(s) Welded	Manual	The AC1 L1 transfer relay is bad or an AC source was wired directly to the AC output.	Disconnect the inverter's output wiring. If error continues, have unit serviced.
F18	Relay(s) Welded	Manual	The AC1 L2 transfer relay is bad or an AC source was wired directly to the AC output.	Disconnect the inverter's output wiring. If error continues, have unit serviced.
F19	Relay(s) Welded	Manual	The AC2 L1 transfer relay is bad or an AC source was wired directly to the AC output.	Disconnect the inverter's output wiring. If error continues, have unit serviced.
F20	Relay(s) Welded	Manual	The AC2 L2 transfer relay is bad or an AC source was wired directly to the AC output.	Disconnect the inverter's output wiring. If error continues, have unit serviced.
F21	Relay(s) Welded	Manual	An unidentified transfer relay is bad or an AC source was wired directly to the AC output.	Disconnect the inverter's output wiring. If error continues, have unit serviced.
F22	Relay(s) Welded	Manual	An unidentified L1 transfer relay is bad or an AC source was wired directly to the AC output.	Disconnect the inverter's output wiring. If error continues, have unit serviced.

**Table 4-6** Fault Messages

<b>Fault Number</b>	<b>Message</b>	<b>Fault Type</b>	<b>Cause</b>	<b>Solution</b>
F23	AI Over Frequency	Automatic	Over-frequency anti-islanding, caught by the AC qualification limit.	No action required. The inverter stops selling and disconnects from the grid. When the fault clears, a five-minute timer begins counting down. The inverter does not sell again until grid voltage and frequency are within range for five minutes.
F24	AI Under Frequency	Automatic	Under-frequency anti-islanding, caught by the AC qualification limit.	See F23.
F25	AI Over Frequency	Automatic	Over-frequency anti-islanding.	See F23.
F26	AI Under Frequency	Automatic	Under-frequency anti-islanding.	See F23.
F27	AI L1 Over Voltage	Automatic	Over-voltage anti-islanding, fast disconnect, 135 VAC.	See F23.
F28	AI L2 Over Voltage	Automatic	See F27.	See F23.
F29	AI L1L2 Over Voltage	Automatic	Over-voltage anti-islanding fault, caught by the qualification limit, voltage difference between L1 and L2.	See F23.
F30	AI L1L2 Over Voltage	Automatic	Over-voltage anti-islanding, fast disconnect, 270 V.	See F23.
F31	AI L1 Over Voltage	Automatic	Over-voltage anti-islanding, slow disconnect, 130 V.	See F23.
F32	AI L2 Over Voltage	Automatic	Over-voltage anti-islanding, slow disconnect, 130 V.	See F23.
F33	AI L1L2 Over Voltage	Automatic	Over-voltage anti-islanding, slow disconnect, 260 V.	See F23.
F34	AI L1 Under Voltage	Automatic	Under-voltage anti-islanding, slow disconnect, 108 V.	See F23.

**Table 4-6** Fault Messages

<b>Fault Number</b>	<b>Message</b>	<b>Fault Type</b>	<b>Cause</b>	<b>Solution</b>
F35	AI L2 Under Voltage	Automatic	See F34.	See F23.
F36	AI L1L2 Under Voltage	Automatic	See F34.	See F23.
F37	AI L1 Under Voltage	Automatic	Under-voltage anti-islanding, fast disconnect, 66 VAC.	See F23.
F38	AI L2 Under Voltage	Automatic	See F37.	See F23.
F39	AI L1L2 Under Voltage	Automatic	Under-voltage anti-islanding fault, caught by the qualification limit, voltage difference between L1 and L2.	See F23.
F40	AI L1L2 Under Voltage	Automatic	Under-voltage anti-islanding, fast disconnect, 132 V.	See F23.
F41	APS Under Voltage	Escalating Auto Fault. Must occur 3 times in 30 seconds before becoming a manual fault.	Auxiliary power supply under-voltage shutdown	Clear the fault and attempt restart. If problem persists, call customer service.
F42	APS Over Voltage	Escalating Auto Fault. Must occur 3 times in 30 seconds before becoming a manual fault.	Auxiliary power supply over-voltage shutdown	Clear the fault and attempt restart. If problem persists, call customer service.

**Table 4-6** Fault Messages

Fault Number	Message	Fault Type	Cause	Solution
F44	Battery Over Temperature	Automatic	Battery over-temperature shutdown at 60 °C.	Clear the fault and attempt restart. Stop charging, check battery voltage and temperature. Check for excessive ambient temperature and adequate ventilation in the battery compartment.  <b>Note:</b> Shutdown temperature is above 60 °C. Recovery occurs at 50 °C where the XW will be enabled again.
F45	Capacitor Over Temperature	Automatic	Capacitor over-temperature shutdown at 105 °C.	Clear the fault and attempt restart. Ensure adequate ventilation around the Conext XW+. Reduce AC loads.
F46	Controller fault	Manual	Controller fault	Service required.
F47	DC Under Voltage	Automatic	DC under-voltage shutdown (immediate) occurs if DC voltage is below 32 V. The fault clears and the inverter restarts when DC voltage reaches V+4 V.	Check for the correct battery voltage at the inverter's DC input terminals. Check for an external DC load on the batteries. Check condition of batteries and recharge if possible.
F48	DC Under Voltage	Automatic	DC under-voltage shutdown occurs if DC voltage is below voltage level.	See F47.
F49	DC Over Voltage	Escalating Auto Fault.	DC over-voltage shutdown. Occurs if DC voltage is above 70 V. The fault can occur when batteries are disconnected at the DC breaker while the Conext XW+ is operating.	Clear the fault and attempt restart. Ensure battery voltage is below 58 VDC at Conext XW+ terminals. Check all other charging source outputs, battery cables. Ensure that batteries are connected, or that your DC source is regulated below your high battery cut out or increase your <b>Hi Batt Cut Out</b> setting.

**Table 4-6** Fault Messages

<b>Fault Number</b>	<b>Message</b>	<b>Fault Type</b>	<b>Cause</b>	<b>Solution</b>
F52	EEPROM Error	Manual		No action. Clear fault and resume operating or configuring the unit. If the fault persists, have the unit serviced.
F53	EEPROM Error	Manual		See F52.
F54	EEPROM Error	Manual		See F52.
F55	EEPROM Error	Manual		See F52.
F56	EEPROM Error	Manual		See F52.
F57	FET1 Over Temperature Shutdown	Automatic	<p>Internal temperature is over 105 °C.</p> <p>AC input voltage may be too high while charging.</p> <p>Operating too large of a load for too long while inverting.</p> <p>Ambient temperature may be high.</p> <p>Inverter cooling fan may have failed.</p> <p>Inverter airflow intake may be blocked.</p> <p>Charging setting is too high based on ambient temperature around inverter.</p>	<p>Fault clears when temperature drops to 75 °C.</p> <p>Check for high input AC voltage.</p> <p>Remove excessive loads.</p> <p>Let inverter cool down and try restarting.</p> <p>Hold a piece of paper to inverter vents to check the fan. If the fan has failed, have the inverter serviced.</p> <p>Increase clearance around the inverter or unclog the fan air intake.</p> <p>Lower the Max Charge Rate setting.</p>

**Table 4-6** Fault Messages

<b>Fault Number</b>	<b>Message</b>	<b>Fault Type</b>	<b>Cause</b>	<b>Solution</b>
F58	FET2 Over Temperature Shutdown	Automatic	See F57.	See F57.
F59	GOCFG process failed	Manual	Auto-configuration process failed.	Retry the “Copy From” procedure, or configure the unit manually.
F63	AC Overload	Escalating Auto Fault. Must occur 3 times in 5 minutes before becoming a manual fault.	Excessive load on the AC output.	Check for loads above the inverter’s capacity. Turn off some loads if necessary. To clear the fault:  Turn off the unit by holding the power button for 5 sec.  Disconnect the Conext XW+ from the battery bank for 20 sec.
F64	AC Overload L1	Escalating Auto Fault. Must occur 3 times in 5 minutes before becoming a manual fault.	Excessive load on the AC output.	See F63
F65	AC Overload L2	Escalating Auto Fault. Must occur 3 times in 5 minutes before becoming a manual fault.	Excessive load on the AC output.	See F63.
F66	System Configuration Fault	Automatic	Multi-Unit Configuration settings are incorrect.	Ensure only one unit is configured as the master. Ensure each unit has a unique Device Number, and that connections have been configured correctly. Ensure there is only one primary charger. See “Connections Menu” on page 3–45.
F67	Watchdog Error	Manual		Service required.



**Table 4-6** Fault Messages

<b>Fault Number</b>	<b>Message</b>	<b>Fault Type</b>	<b>Cause</b>	<b>Solution</b>
F68	Transformer Over Temperature	Automatic	The transformer temperature is over 140 °C.	The fault clears when the transformer temperature falls to 125 °C. Ensure adequate ventilation around the Conex XW+. Reduce AC loads.
F69	External Sync Failed	Manual		Check connections and cable on external AC sync port. In a single-inverter system, nothing must be plugged into the AC sync port. Clear fault and try again. If these steps fail, the unit requires service.
F70	Check Phase Configuration	Automatic	The unit cannot qualify its AC input because of an incorrect three-phase installation. For example, phase B and phase C are reversed, either through miswiring or incorrect Connections and Inverter Mode settings.	<ol style="list-style-type: none"> <li>1. Make sure that only one unit on each phase is configured as the master. Make sure each unit has a unique Device Number and that Inverter Mode and Connections have been configured correctly. See “Three-Phase Configuration” on page 3–43 and “Connections Menu” on page 3–45.</li> <li>2. Disconnect all units and make sure that the three-phase wiring is correct.</li> </ol>
F71	Battery Discharge Over Current	Manual	There is an excessive load on the Li-Ion battery. (The fault applies only to Li-Ion batteries.)	Change the default threshold of the max battery discharge current limit or reduce the load.
F72	External AC Contactor Malfunction	Manual	The External AC Contactor was not set as expected.	Check why the AC contactor has failed. Check for fusing of coil, wiring and connections. Verify that the AC contactor has power.
F500	Silicon Serial ID Failure	Manual	Silicon Serial ID Failure	Service required.



# A

# Specifications

Appendix A, “Specifications” provides the electrical and mechanical specifications for the Conext XW+ Inverter/Charger.

---

#### **DISCLAIMER REGARDING STATUS DATA**

STATUS DATA REPORTED BY THE XW/XW+ INVERTER/CHARGER (THE “XW/XW+”) ARE APPROXIMATE VALUES INTENDED TO PROVIDE GENERAL AND NON-EXACT INFORMATION ABOUT THE XW/XW+ SYSTEM. UNDER NO CIRCUMSTANCES SHOULD THIS STATUS DATA BE USED FOR PRECISE EVALUATION OF THE XW/XW+ AND/OR SYSTEM PERFORMANCE, INCLUDING EFFICIENCY CONSIDERATIONS. IN SYSTEMS WITH A SINGLE XW/XW+ UNIT, THE MEASUREMENT CAPABILITIES OF THE XW/XW+ ALLOW FOR DEVIATIONS OF UP TO 5% OF ACTUAL VALUES. IN SYSTEMS WITH MULTIPLE XW/XW+ UNITS, THE COMPOUNDED EFFECT OF ACCURACY DEVIATIONS IN THE STATUS DATA COULD RESULT IN AGGREGATED DEVIATIONS EXCEEDING 5% OF ACTUAL VALUES. FOR SYSTEMS REQUIRING HIGHER ACCURACY STATUS REPORTING OF AC PARAMETERS, SCHNEIDER ELECTRIC RECOMMENDS THE USE OF EXTERNAL MONITORING EQUIPMENT OF APPROPRIATE AND ACCURATE CALIBRATION. FOR HIGHER ACCURACY MEASUREMENT OF DC (BATTERY) PARAMETERS, SCHNEIDER ELECTRIC RECOMMENDS INSTALLING AN APPROPRIATE DC BATTERY MONITOR IN THE SYSTEM.

---

## Electrical Specifications

**Note:** Specifications are subject to change without prior notice.

**Table A-1** Conext XW+ Inverter/Charger Electrical Specifications

	Conext XW+ 6848 NA	Conext XW+ 5548 NA
Continuous Output Power	6,800 W	5,500 W
Surge Rating (Overload for 1 minute)	12,000 W	9,500 W
Surge Rating (Overload for 5 minutes)	11,000 W	9,000 W
Surge Rating (Overload for 30 minutes)	8,500 W	7,000 W
Surge Current	L-N: 104 A <sub>rms</sub> (60 s) L-L: 52 A <sub>rms</sub> (60 s)	L-N: 82 A <sub>rms</sub> (60 s) L-L: 41 A <sub>rms</sub> (60 s)
Waveform	True Sine Wave	
Idle Consumption—Inverter mode, no load	28 W	26 W
Idle Consumption—Search mode	< 8 W	
AC Output Voltage	L-N: 120 VAC ±3% L-L: 240 VAC ±3%	
AC Input Voltage range (Bypass/Charger Mode)	L-N: 78–140 VAC (120 V nominal) L-L: 160–270 VAC (240 V nominal)	
AC Input Breaker	60 A double-pole	
AC Input Frequency Range (Bypass/Charger Mode)	52–68 Hz (default) 44–70 Hz (allowable)	
AC Output Current (maximum 75% imbalance between L1-N, L2-N) in Inverter Mode	L-N: 48 A L-L: 28 A	L-N: 46 A L-L: 23 A
AC Output Breaker	60 A double-pole	
AC Output Frequency	60.0 ±0.1 Hz	
Total Harmonic Distortion	< 5% at rated power	
Automatic Transfer Relay	60 A	
Auxiliary Relay Output	0–12 VDC, maximum 250 mA DC	
Peak Efficiency	95.7%	95.7%
CEC Weighted Efficiency	92.5%	93.0%
CEC Power Rating	6,000 W <sup>a</sup> 5,760 W <sup>b</sup>	4,400 W
DC Input Voltage (Nominal)	48 VDC	
DC Input Voltage Range	40–64 VDC	40–64 VDC
DC Current at Rated Continuous Power (Inverter Mode)	180 A	150 A

**Table A-1** Conext XW+ Inverter/Charger Electrical Specifications

	Conext XW+ 6848 NA	Conext XW+ 5548 NA
Continuous Charge Rate at L-L voltage (Charger Mode)	140 A	110 A
Power Factor Corrected Charging	PF (0.98)	
Typical Transfer Time	8 ms	

a. Conext XW+ 6848 NA (Part Number 865-6848-01)

b. Conext XW+ 5548 NA (Part Number 865-5548-01)

## Grid-tie Specifications

**Note:** Specifications are subject to change without prior notice.

Function	120 V/240 V	120 V	Response Time
Anti-islanding reconnect	254.4 V ( $\pm 3$ V)	127.2 V ( $\pm 3$ V)	300 s (+1/-0 s)
Over frequency disconnect	60.5 Hz ( $\pm 0.05$ Hz)	60.5 Hz ( $\pm 0.05$ Hz)	60 ms ( $\pm 20$ ms)
Under frequency disconnect	59.3 Hz ( $\pm 0.05$ Hz)	59.3 V ( $\pm 0.05$ Hz)	60 ms ( $\pm 20$ ms)
Over voltage LN fast disconnect	135 V ( $\pm 1.5$ V)	135 V ( $\pm 1.5$ V)	60 ms ( $\pm 25$ ms)
Over voltage LN slow disconnect	132 V ( $\pm 1.5$ V)	132 V ( $\pm 1.5$ V)	500 ms ( $\pm 50$ ms)
Over voltage L1/L2 fast disconnect	270 V ( $\pm 3$ V)	-	60 ms ( $\pm 25$ ms)
Over voltage L1/L2 slow disconnect	264 V ( $\pm 3$ V)	-	500 ms ( $\pm 50$ ms)
Under voltage LN fast disconnect	67 V ( $\pm 5$ V)	75 V ( $\pm 5$ V)	60 ms ( $\pm 25$ ms)
Under voltage LN slow disconnect	105.6 V ( $\pm 1.5$ V)	105.6 V ( $\pm 1.5$ V)	1000 ms ( $\pm 40$ ms)
Under voltage L1/L2 slow disconnect	211.2 V ( $\pm 3$ V)	-	100 ms ( $\pm 40$ ms)
Under voltage L1/L2 fast disconnect	150 V ( $\pm 10$ V)	-	60 ms ( $\pm 25$ ms)

## Response to Abnormal Grid Conditions

**Note:** Specifications are subject to change without prior notice.

Category	Function	Fixed Setting	Nominal Clearing Time
Abnormal Voltage Fast (VAC)	HECO TOV VAC High Off	288 V (split-phase) 144 V (single-phase)	< 1 cycle
	VAC High Off	270 V ( $\pm 3$ V)	60 ms
	VAC High On	$\leq 252$ V	300 s
	VAC Low Off	150 V ( $\pm 3$ V)	60 ms
	VAC Low On	$> 214$	300 s
Abnormal Voltage Slow (VAC)	VAC High Off Slow	264 V ( $\pm 3$ V)	500 ms
	VAC High On Slow	$\leq 252$ V	300 s
	VAC Low Off Slow	211 V ( $\pm 3$ V)	1 s
	VAC Low On Slow	$> 214$ V	300 s
Abnormal Frequency (Hz)	FAC High Off	60.5 Hz ( $\pm 0.05$ Hz)	100 ms
	FAC High On	$< 60.45$ Hz	300 s
	FAC Low Off	59.3 Hz ( $\pm 0.05$ Hz)	100 ms
	FAC Low On	$> 59.35$ Hz	300 s
Reconnect Time (s)	–	300 s	–

## Conext XW+ Overload Capability

Loads connected to the inverter are seldom constant, and large loads are often operated for short periods. To accommodate larger loads, the Conext XW+ can temporarily exceed its continuous output power rating.

The graphs below illustrate approximate operation time versus load. Inverter operation time during overload is limited by both inverter internal temperature protection and by the product of AC output current and elapsed time.

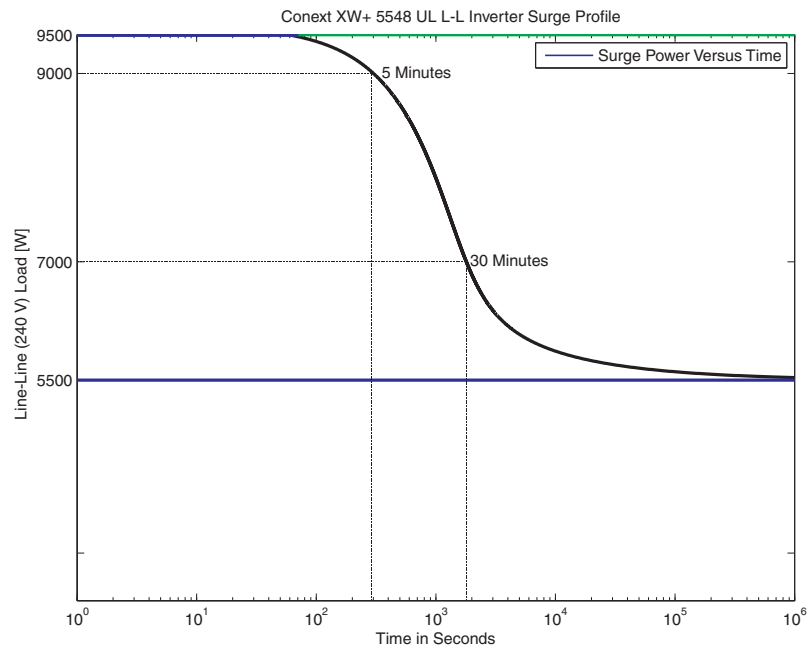

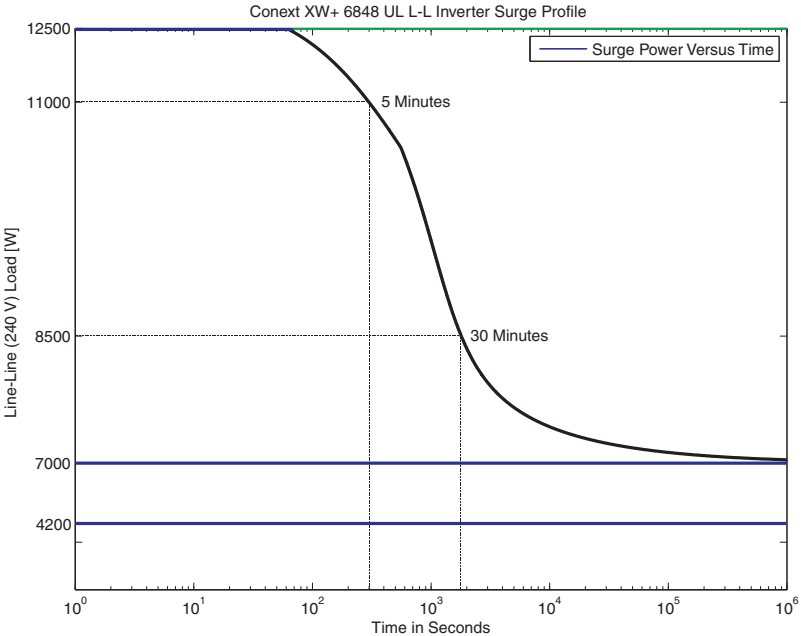
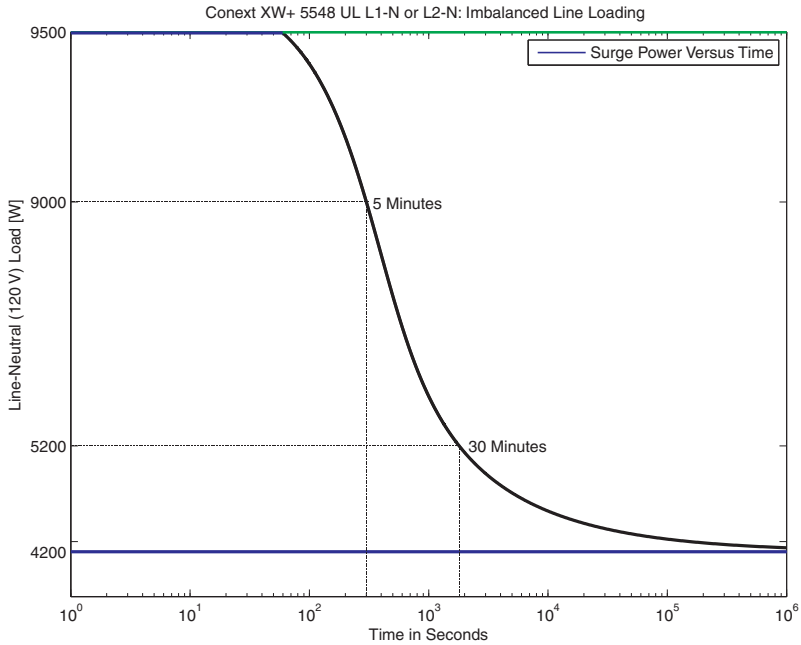



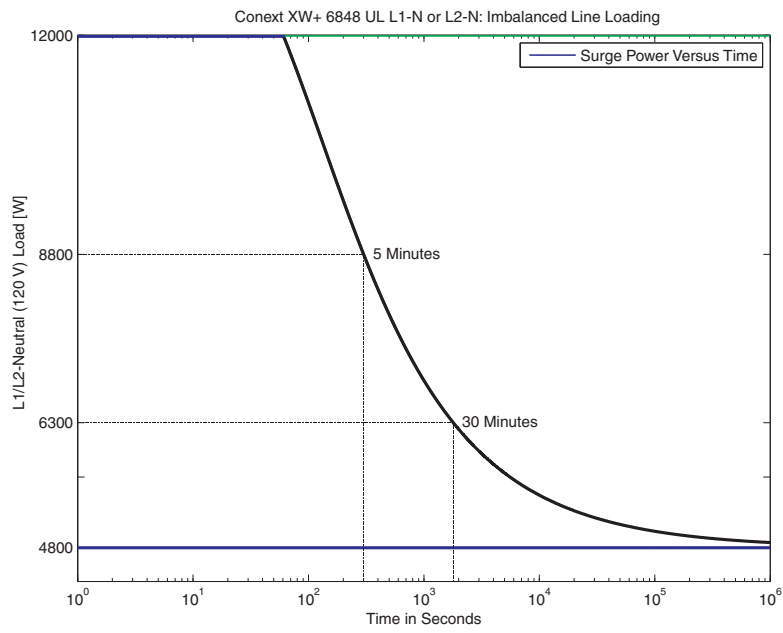

**Figure A-1** Conext XW+ AC Overload Capability

## Output Power Versus Ambient Temperature

**Note:** For the Conext XW+ 6848 model, the power can be limited by the installed DC and AC breakers. For example, at 8500 W the DC or AC breakers may disconnect before the 30 minute rating.

When the internal temperature of the Conext XW+ exceeds a preset limit, it begins to limit output power automatically to stop maximum internal temperatures from being exceeded.

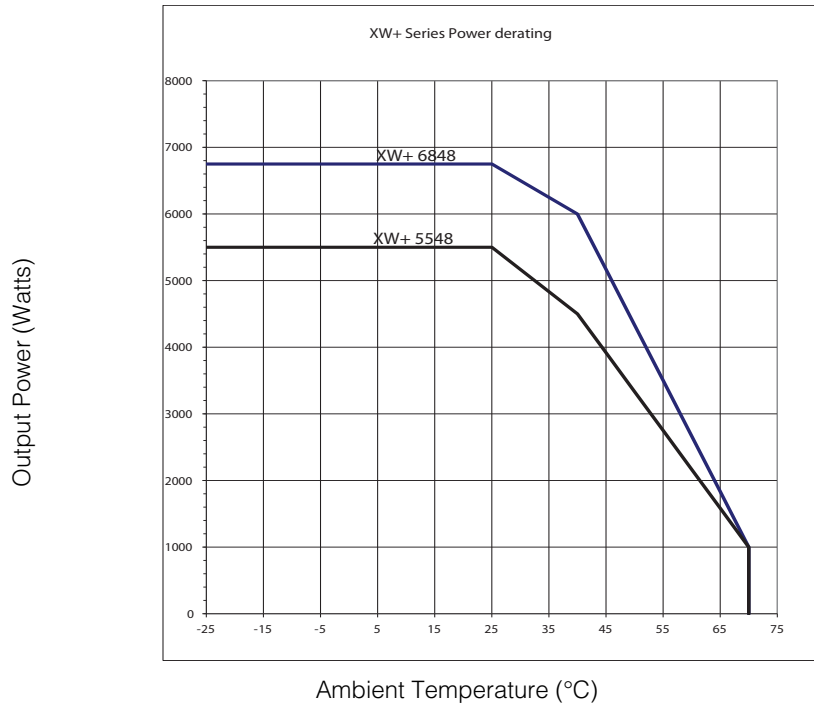

Figure A-2 Output Power Versus Ambient Temperature

## Conext XW+ Efficiency

### Inverting Efficiency (Typical)

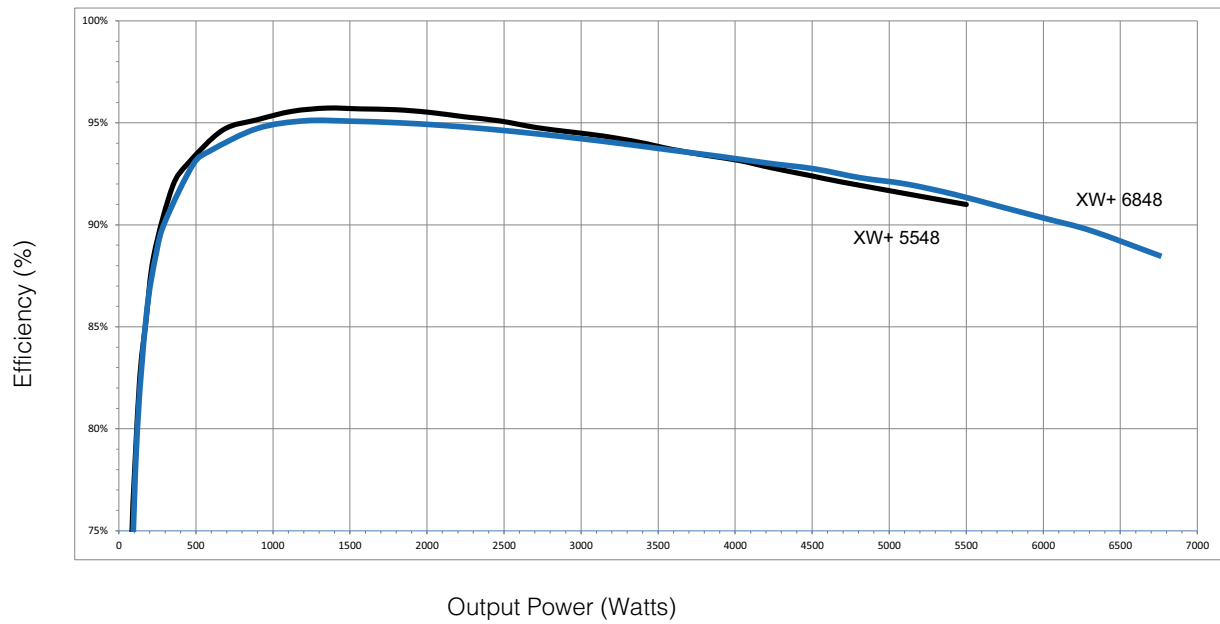

Figure A-3 Inverting Efficiency (Typical)

### Charging Efficiency (Typical)

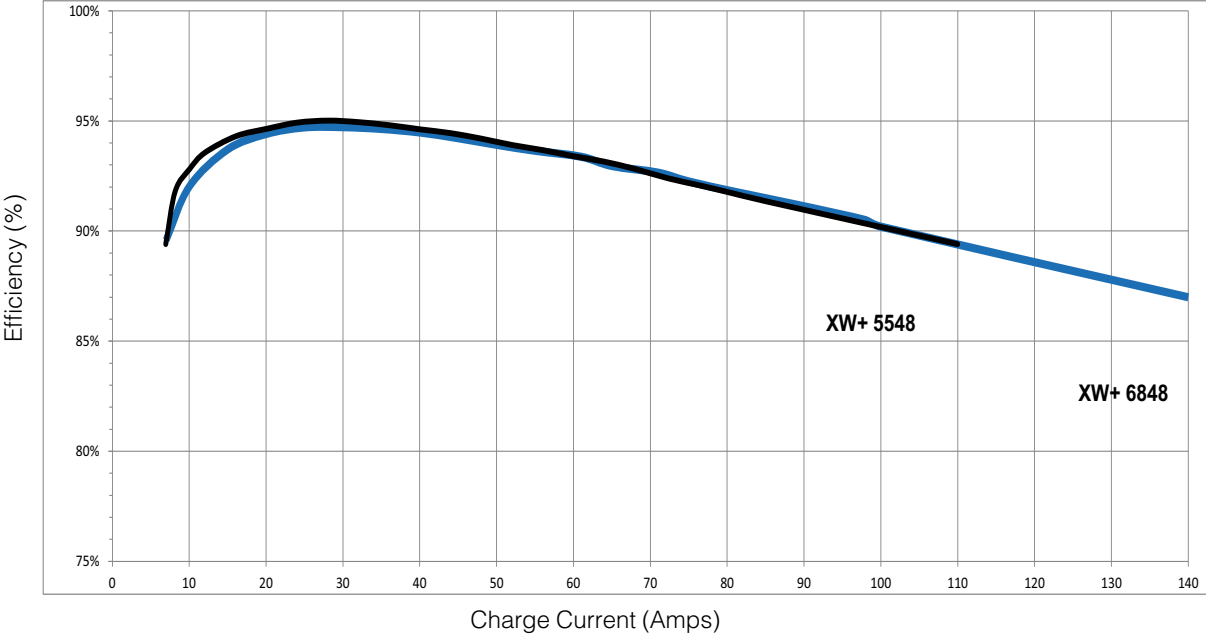

Figure A-4 Charging Efficiency (Typical)

### Charging Efficiency Power Factor

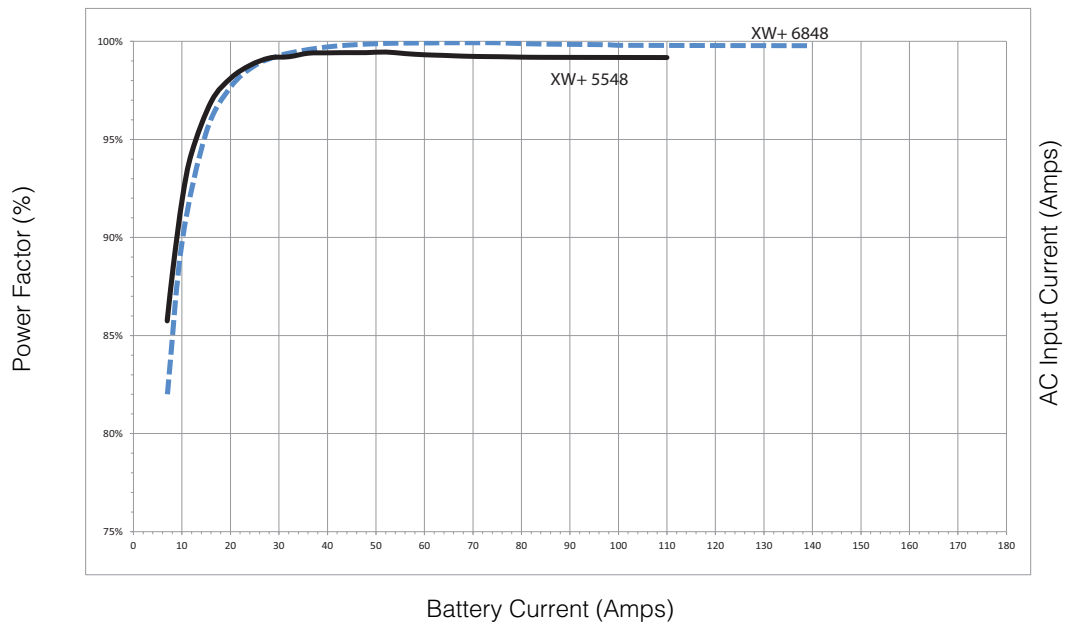

Figure A-5 Charging Efficiency (Power Factor)

## Mechanical Specifications

**Note:** Specifications are subject to change without prior notice.

**Table A-2** Conext XW+ Inverter/Charger Mechanical Specifications

Model	Conext XW+ 6848 NA	Conext XW+ 5548 NA
Supported Battery Types	Flooded (default), Gel, AGM, Lithium Ion, Custom	
Battery bank size	440–10000 Ah	
Non-Volatile Memory	Yes	
Inverter Information Panel	Status LEDs indicate AC In status, faults/warnings, equalize mode, battery level. 3-character display indicates output power or charge current, fault/warning codes. STARTUP/SHUTDOWN and equalize button	
Multiple Unit Configurations	Clusters of up to 3 parallel units in 120/240 three-wire, single-phase configuration. Up to 4 clusters possible using multi-cluster for a total of 12 units when using an external AC contactor.	
System Network	Conext Xanbus™ (publish-subscribe network, no need for hubs or special cards)	
Emissions	FCC Part 15, Class B Industry Canada ICES-003 Issue 5, Class B	
Regulatory approvals	CSA C22.2 No. 107.1-01 - General Use Power Supplies UL 1741 - 2nd Ed - Inverters, Converters, Controllers and Interconnection System Equipment	
Enclosure Type	NEMA Type 1—Indoor	
Rated Temperature Range (meets specifications)	32–77 °F (0–25 °C)	
Operational Temperature Range	-13–158 °F (-25–70 °C)	
Storage Temperature Range	-40–185 °F (-40–85 °C)	
Inverter Dimensions (H × W × D)	23 × 16 × 9" (580 × 410 × 230 mm)	
Shipping Dimensions (H × W × D)	28 × 22 ½ × 15 ½" (711 × 572 × 394 mm)	
Inverter Weight	125 lb (57 kg)	115 lb (52 kg)
Shipping Weight	132 lb (60 kg)	122 lb (55 kg)

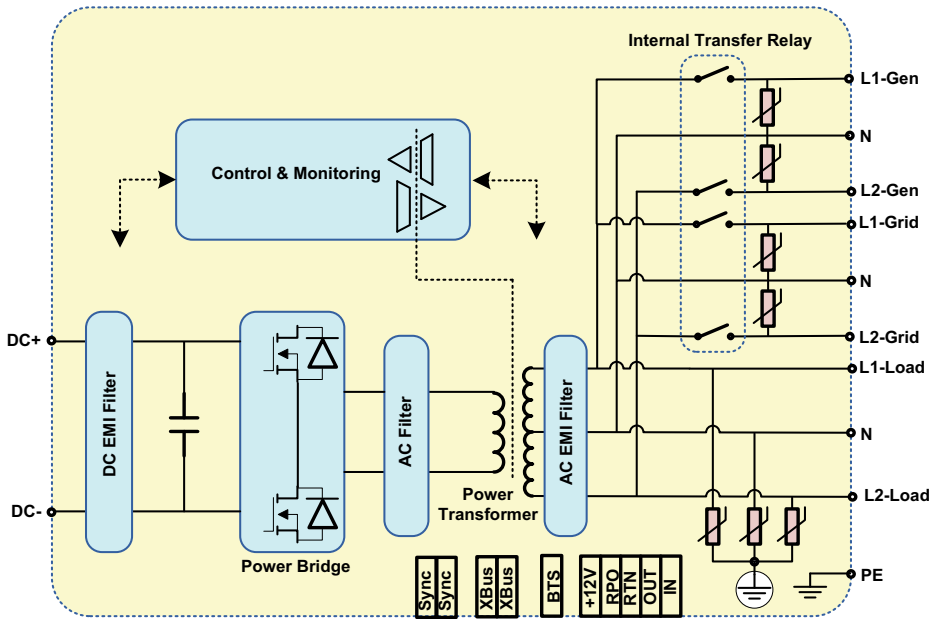

Figure A-6 Conext XW+ Block Diagram

## Accessories

Accessory	Part Number
Conext XW+ Power Distribution Panel	865-1015-01
Conext XW+ Power Distribution Panel (Without AC Breakers)	865-1014-01
Conext XW+ Conduit Box	865-1025-01
Conext XW+ Connection Kit	865-1020-02
Conext System Control Panel	865-1050-01
Conext Automatic Generator Start	865-1060-01
Conext MPPT 60 150 Solar Charge Controller	865-1030-1
Conext MPPT 80 600 Solar Charge Controller	865-1032
Conext ComBox	865-1058
Conext Battery Monitor	865-1080-01
Conext XW+ PDP 120/240V 60A Breaker Kit	865-1215-01
Conext XW+ PDP 3-Phase 60A Breaker Kit	865-1315-01





# B

## Default Settings

Appendix B contains the default configuration settings and ranges for the Conext XW+ Inverter/Charger. Configuration settings can be viewed and changed using the Conext System Control Panel.

## Default Settings and Ranges

Figure B-1 shows how the advanced Conext configuration menus are organized in the Conext System Control Panel.

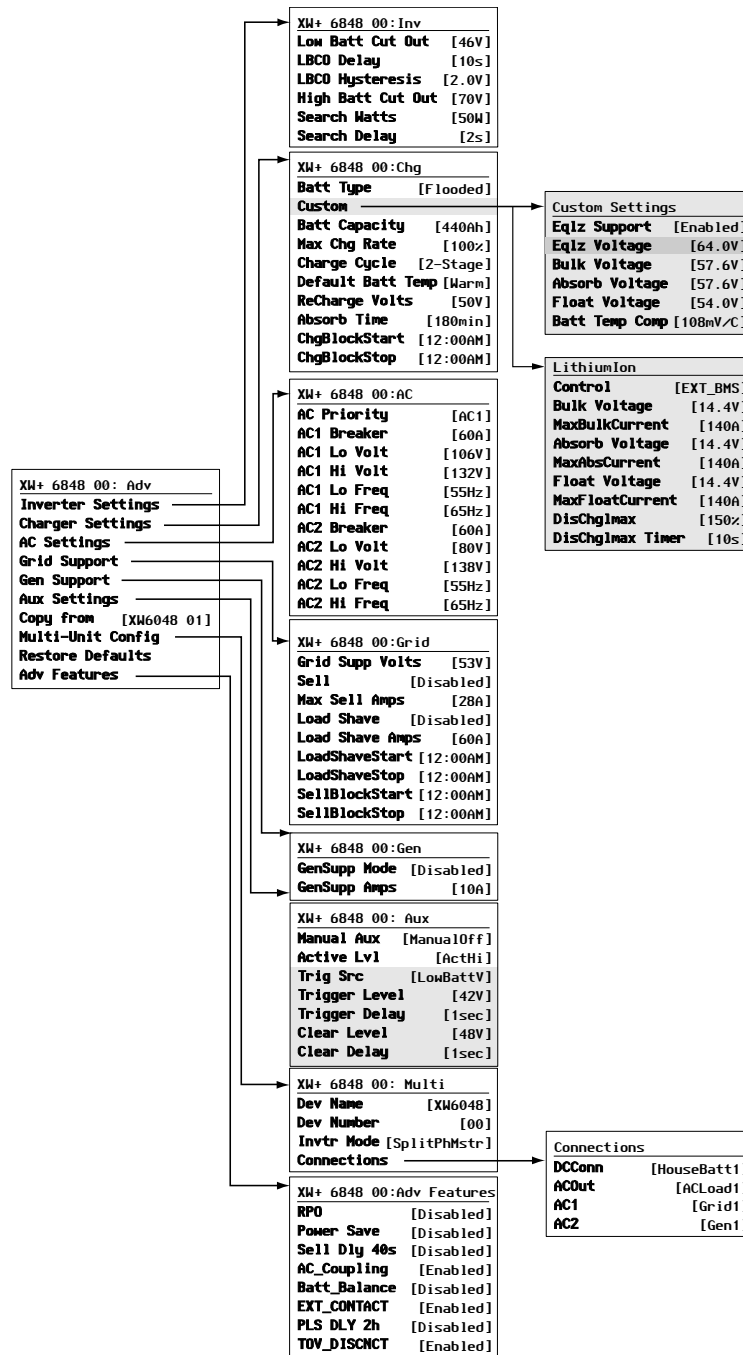

Figure B-1 Configuration Menu Map (Advanced)

## Inverter Settings Menu

Item	Default Setting	Range	Step Size
Low Batt Cut Out	46 V	40–48 V	0.1
LBCO Hysteresis	2 V	0-10 V	0.1
LBCO Delay	10s	0–600s	1
High Batt Cut Out	70 V	58–70 V	0.1
Search Watts	50 W	25–255 W	5
Search Delay	2s	1–25s	1

## Charger Settings Menu

Item	Default Setting	Range	Step Size
Batt Type	Flooded	Flooded, Gel, AGM, Custom <sup>a</sup>	n/a
Batt Capacity	440 Ah	0–10000 Ah <sup>b</sup>	1
Max Chg Rate	100%	5–100%	1
Charge Cycle	2-Stage	2-Stage, 3-Stage	n/a
Default Batt Temp	Warm	Cold, Warm, Hot	n/a
ReCharge Volts	50 V	40.0–54.0 V	0.1
Absorb Time	180 min	1–480 min	1
Chg Block Start	12:00 AM	12:00 AM–11:59 PM, 00:00–23:59	1
Chg Block Stop	12:00 AM	12:00 AM–11:59 PM, 00:00–23:59	1

a. When Custom battery selected, two sub-menus appear: **Custom Settings** and **LithiumIon**

b. Setting the battery capacity to 0 will reset the charging current to its default values. Zero Ah battery capacity implies there is no absorption exit current criteria and absorption only exits when the absorption timer (default 3 hrs, range 1 min-8 hr) expires.

## Custom Settings Submenu

Item	Default Setting	Range	Step Size
EqLz Support	Enabled	Enabled, Disabled	n/a
EqLz Voltage	64.0 V	54.0–64.0 V	0.1
Bulk Voltage <sup>a</sup>	57.6 V 56.8 V (Gel) 57.2 V (AGM)	54.2–64.0 V	0.1
Absorb Voltage <sup>a</sup>	57.6 V 56.8 V (Gel) 57.2 V (AGM)	40.0–64.0 V	0.1
Float Voltage <sup>a</sup>	54.0 V 55.2 V (Gel) 53.6 V (AGM)	50.0–64.0 V	0.1

## Default Settings

Item	Default Setting	Range	Step Size
Batt Temp Comp <sup>a</sup>	108 mV/C (Flooded, Gel) 84 mV/C (AGM)	0-180 mV/C	1

a. Custom battery default settings are based on the Flooded battery default settings. The Gel and AGM default settings are provided here for reference only.

## LithiumIon Submenu

Item	Default Setting	Range	Step Size
Control	EXT_BMS	EXT_BMS, 3stage, 2stage NoFloat	n/a
Bulk Voltage	57.6 V	54.2-64.0 V	0.1
Max Bulk Current	140 A	10-140 A	1
Abs Voltage	57.6 V	40.0-64.0 V	0.1
Max Abs Current	140 A	10-140 A	1
Float Voltage	54.0 V	50.0-64.0 V	0.1
Max Float Current	140 A	1-140 A	1
DisChgImax	150%	20-500%	1
DisChgImax Timer	10 sec	0-300 sec	1

## AC Menu

Item	Default Setting		Range		Step Size
	120 VAC	240 VAC	120 VAC	240 VAC	
AC Priority	AC1		AC1, AC2		n/a
AC1 Breaker	60 A		3-60 A		1
AC1 Lo Volt	106 V	212 V	78-115 V	156-230 V	1
AC1 Hi Volt	132 V	264 V	125-140 V	250-280 V	1
AC1 Lo Freq	55 Hz		44-59 Hz		1
AC1 Hi Freq	65 Hz		61-70 Hz		1
AC2 Breaker	60 A		3-60 A		1
AC2 Lo Volt	80 V	160 V	78-115 V	156-230 V	1
AC2 Hi Volt	138 V	276 V	125-140 V	250-280 V	1
AC2 Lo Freq	55 Hz		44-59 Hz		1
AC2 Hi Freq	65 Hz		61-70 Hz		1

## Grid Support Menu

Item	Default	Range	Step Size
Grid Supp Volts	53.0 V <sup>a</sup>	42.0–70.0 V	0.1
Sell	Disabled	Disabled, Enabled	n/a
Max Sell Amps <sup>b</sup>	27 A (XW+ 6848), 20 A (XW+ 5548)	0–27 A (XW+ 6848), 0–20 A (XW+ 5548)	1
Load Shave	Disabled	Disabled, Enabled	n/a
Load Shave Amps	48 A	0–48 A	1
Load Shave Start <sup>c</sup>	12:00 AM	12:00 AM–11:59 PM, 00:00–23:59	1
Load Shave Stop	12:00 AM	12:00 AM–11:59 PM, 00:00–23:59	1
Sell Block Start	12:00 AM	12:00 AM–11:59 PM, 00:00–23:59	1
Sell Block Stop	12:00 AM	12:00 AM–11:59 PM, 00:00–23:59	1

a. The setting for Grid Supp Volts must be greater or equal to LBCO+2 V. For example, if LBCO is 44 V then the minimum Grid Supp Volts is 46 V.

b. This setting is restricted to the selected external AC1 breaker size.

c. When Load Shaving is enabled, if Load Shave Start and Load Shave Stop are set to the same time, the Conext load shaves continuously.

## Gen Support Menu

Setting	Default	Range	Step Size
GenSupp Mode	Disabled	Enabled, Disabled	n/a
GenSupp Amps	48 A	0–48 A	1

## Aux Menu

Item	Default	Range	Step Size
Manual Aux	ManualOff	ManualOn, ManualOff, Automatic	n/a
Active Lvl	ActiveHigh	ActiveHigh, ActiveLow	n/a
Trig Src <sup>a</sup>	LowBattV	LowBattV, HighBattV, LowBattTemp, HighBattTemp, Fault	n/a
Trigger Level— LowBattV <sup>b</sup>	46.0 VDC	20.0–58.0 VDC	0.1
Clear Level—LowBattV	48.0 VDC	20.0–58.0 VDC	0.1
Trigger Level—HighBattV	56.0 VDC	48.0–64.0 VDC	0.1
Clear Level—HighBattV	52.0 VDC	48.0–64.0 VDC	0.1

## Default Settings

Item	Default	Range	Step Size
Trigger Level—HighBattTemp	45.0°C	30.0–60.0°C	1
Clear Level—HighBattTemp	35.0°C	30.0–60.0°C	1
Trigger Level—LowBattTemp	0.0°C	-30.0–10.0°C	1
Clear Level—LowBattTemp	5.0°C	-30.0–10.0°C	1
Trigger Delay	1s	0–600s	1
Clear Delay	1s	0–600s	1

a. The Trigger Src setting (and the settings below Trigger Src) appear only if Manual Aux setting has been set to Automatic.

b. Trigger Level, Trigger Delay, Clear Level and Clear Delay do not appear if Trigger Src is set to Fault.

## Connections Menu

Item	Default	Range	Step Size
DCConn	HouseBatt1	HouseBatt1–6	n/a
ACOut	ACLoad1	ACLoad1–10	n/a
AC1	Grid 1	None, Grid1–10, Gen1–10	n/a
AC2	Gen 1	None, Grid1–10, Gen1–10	n/a

## Advanced Features Menu

Item	Default	Range	Step Size
RPO	Disabled	Enabled, Disabled	n/a
Power Save	Disabled	Enabled, Disabled	n/a
Sell Dly 40s	Disabled	Enabled, Disabled	n/a
AC_Coupling	Enabled	Enabled, Disabled	n/a
Batt_Balance	Disabled	Enabled, Disabled	n/a
EXT_CONTACT	Enabled	Enabled, Disabled	n/a
PLS DLY 2h	Disabled	Enabled, Disabled	n/a
TOV_DISCNCT <sup>a</sup>	Enabled	Enabled, Disabled	n/a

a. Hawaii HECO TOV requirement

For an explanation of these features, see “Using the Advanced Features” on page 3–49.

# Index

## Numerics

- 2-stage charge mode 16
- 3-stage charge mode 13

## A

- absorption charging stage 14
- AC Coupling 8
- AC settings menu
  - default settings 4
  - description 23
- AC Transfer 10
- accessories 13
- advanced features menu 49
- advanced menu 4
- APF Mode 16
- automatic faults 17
- automatic generator start 9
- auxiliary output menu
  - default settings 5
  - description 36

## B

- battery level LEDs 8
- battery type 11
- bidirectional theory of operation 3
- boost charging stage 15
- bulk charging stage 14

## C

- charger block 11, 30
- charger settings menu
  - default settings 3
  - description 11
- charger status LED 4
- charging cycle diagram 13
- Conext SCP
  - device setup menus 13
  - features 12, 2, 10
  - select device menu 13
  - system status screen 13
- connections menu
  - default settings 6
  - description 45
- custom battery menu 21

## D

- default settings, restoring 48
- device home screen 14
- display screen 8
- down arrow button 10

## E

- electrical specifications 2
- energy management features 28
- enter button 10
- equalize button and LED 5
- equalize mode 17
- escalating automatic faults 17
- event LED (Inverter Information Panel) 4
- exit button 10

## F

- fault types 17
- fault/warning LED (System Control Panel) 10
- faults and warnings 10
- features 2
- float charging stage 16

## G

- Gen (AC2) LED 2
- generator support 16
- generator support menu
  - default settings 5
  - description 34
- Grid (AC1) LED 2
- grid support 16
- grid support settings menu
  - default settings 5
  - description 25

## H

- home screen 14

## I

- inverter information panel 11
  - monitoring with 2
- inverter settings menu
  - default settings 3
  - description 8
- inverter status LED 3
- islanding 7

## **K**

K1 and K2 relay 10  
keypress for system standby mode 11  
kW LED 3

## **L**

LBCO setting 9  
load shave 16, 26, 32

## **M**

manual faults 17  
mechanical specifications 12  
menu map 7, 2  
meters screen 17  
multi-stage charging process 13  
multi-unit operation 9

## **N**

no float charging stage 16

## **P**

passthru 17  
peak load shaving 32  
performance 2  
Power Save 49, 6

## **Q**

qualifying AC 15

## **R**

recharge volts 11  
restore default settings 48  
RPO 49, 6

## **S**

search mode 17, 2, 8, 9  
self-consumption 33  
sell mode 17, 26  
setup menus 13  
specifications  
    electrical 2  
    mechanical 12  
standby 17  
standby button 10, 11  
startup/shutdown button 6  
state of charge LEDs 8  
surge performance 7  
System Control Panel. See Conext SCP  
system home screen 12

system standby mode 11  
system status screen 13

## **T**

three-stage charge mode 13  
time-of-use (TOU) metering 32  
troubleshooting  
    fault messages 16  
    general guidelines 2  
    motor loads 3  
    problem loads 3  
    resistive loads 3  
    warning messages 11  
two-stage charge mode 16

## **U**

Up arrow button 10

## **W**

warning  
    automatic 11  
    manual 12

## **X**

Xanbus™ 2





## Schneider Electric

[solar.schneider-electric.com](http://solar.schneider-electric.com)

As standards, specifications, and designs change from time to time, please ask for confirmation of the information given in this publication.

© 2015 Schneider Electric. All rights reserved.

975-0240-01-01 Revision F

Printed in China