



# FLEXware Integration Guide



# Welcome



OutBack Power Systems is proud to begin another year of designing and manufacturing solutions with you, the customer, in mind. OutBack maintains the philosophy that listening to our customers and innovating to meet their needs is paramount to our success.

This past year OutBack's engineering, marketing and operations teams have been focusing on taking the suggestions provided by our customers to develop a new line of products called FLEXware. FLEXware is an evolution in balance of system components which are simple to order, easy to assemble and fast to install. In conjunction with this product development, we have made efforts to further enhance our industry-leading level of customer service by building our team of qualified technical and order service personnel.

OutBack is excited about what the future will bring. We will continue to listen to and learn from our customers, and continue to innovate. The power electronics and communications technologies we have developed over the past several years will allow OutBack to continue to provide the cutting edge solutions our customers are looking for as we move ahead.

We are confident that OutBack will continue to lead the way in bringing the solutions and services that people have come to depend on.

Thank you for your support as we continue *Powering the Planet*.

## History

**2001 OutBack was started by a passionate group of engineers who wanted to bring power conversion electronics technology into the 21st century.**

This small startup quickly grew by offering innovative and well designed solutions to renewable energy problems. OutBack listened to their customers and made many of the changes that were suggested, creating a truly customer focused company in the power conversion electronics industry.

**2002 OutBack introduces its first sealed sinewave inverter/charger, the FX2024 - with resounding success.**

This single model changed the way people looked at system design by offering unprecedented flexibility in system design and expansion while the sealed construction allowed for uses which previously would have been considered too "extreme" for other inverter/chargers.

OutBack releases the MX60 solar MPPT Charge Controller redefining performance and value.

This revolutionary product changed the way solar systems were being installed and quickly gained a reputation for getting the most power possible from a PV array - often making it more expensive to not use one.

**2003 OutBack launches the first of the vented versions of the FX Series inverter/chargers.**

These VFX models were introduced in direct response to our customer's requests providing higher power at a similar price as the sealed counterpart.

OutBack launches the PS2, value priced system integration accessories.

This line of accessories addressed the needs of our customers for competitively priced system integration accessories for smaller systems.

**2004 OutBack releases the world's most efficient grid-interactive inverter/charger.**

These models raise the bar for performance and value for battery-connected grid-interactive inverter/charger systems. OutBack introduces the PS1 fully integrated grid-interactive power system.

This unique system sets a new standard for system integration, performance and ease of installation in grid-interactive applications.

**2005 OutBack reaches milestones in product deliveries and product recognition.**

**MX60 and FX Inverter production lines each ship 10,000th unit.**

OutBack Power equipped teams sweep the top three places in the 2005 Solar Decathlon, a competition between International universities to develop and build the most energy efficient home.

**2006 OutBack launches FLEXware, a new line of balance of system components.**



# Introducing the FLEXware System

FLEXware is the latest example of OutBack's continuous efforts to bring you the most value packed and technologically advanced products available.

Our integrating partners, dealers, installers, and system owners spoke—and we listened. The resulting FLEXware is the most integrated, modular, and spacious installation system OutBack has ever designed. Its components are more versatile, the wiring space is larger, and the all-aluminum, powder-coated construction not only resists corrosion longer, but is lighter and easier to handle than our previous steel construction. OutBack's new FLEXware makes for a great looking installation that will look great for years and years to come.

Designed to work as a modular “building block” architecture, FLEXware offers more versatility than ever before. From single inverter back-up systems to a multiple inverter village power system – FLEXware is the solution.

The FLEXware 250 offers the lowest cost solution for single inverter/charger installations when space and budget are primary concerns.

The FLEXware 500 supports up to two inverter/chargers and two charge controllers in an attractive, versatile and code-compliant package when more power is needed.

The FLEXware 1000 accommodates up to four inverter/chargers and four charge controllers. It can also be used for large systems with multiple power panels for systems up to 36 kW.

Both the FLEXware 500 and FLEXware 1000 systems provide ample locations for additional breakers, DC current shunts, an autotransformer and other items required in higher kW systems.

The new FLEXware MP mounting plate shows the versatility of the FLEXware system with its compatibility with both the FLEXware 500 and FLEXware 1000 systems.

All of the FLEXware options have also been simplified, making the design, ordering and installation of power system easier than ever.



# FLEXware 250



For applications with modest power requirements such as cabins, remote communication sites and back-up power systems. The FLEXware 250 accommodates all of the essential protective devices in the smallest possible space at the lowest installed cost. Utilizing an extremely compact design and unique mounting features, one or two FLEXware 250 enclosures can be mounted on each end of a single FX Series Inverter/Charger. The FLEXware 250 enclosure is constructed of power-coated aluminum and has been ETL listed. It provides breaker spaces for battery, PV array or PV GFP breakers and mounting locations for AC GFCI outlet, AC breakers and even an Input-Output-Bypass Assembly. In keeping with the philosophy of FLEXware, the FLEXwares 250 flexibility is evident in the generous number of knock-outs allowing the installation of conduit, cable glands and other installation accessories.

## Breaker Configuration Diagram

### AC Side

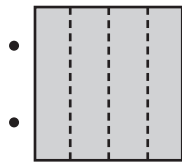

Holds up to four small 0.75" (19 mm) wide AC rated panel mount breakers (not included). The small sizes are rated for 1-60 Amps of AC current. Support for optional AC Input-Output-Bypass Assembly.



Holds one ground fault duplex receptacle.

### DC Side



Holds one large 1.5" (39 mm) wide 175 or 250 Amp breaker. Includes large DC breaker guard.

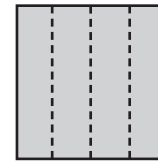

Holds up to four small 0.75" (19 mm) wide DC rated panel mount breakers (not included). The small sizes are rated for 1-80 Amps of DC current.

## Knockout Location Diagram

### AC Side

- (1) 2" knockout (2.468" diameter)
- (1) 1" knockout (1.359" diameter)
- (1) ¾" knockout (1.093" diameter)

### DC side

- (1) 2" knockout (2.468" diameter)
- (2) ½" knockout (0.875" diameter)

### Back

- (1) 2" knockout (2.468" diameter)
- (2) 1" knockout (1.359" diameter)

### Bottom

- (1) 2" knockout (2.468" diameter)

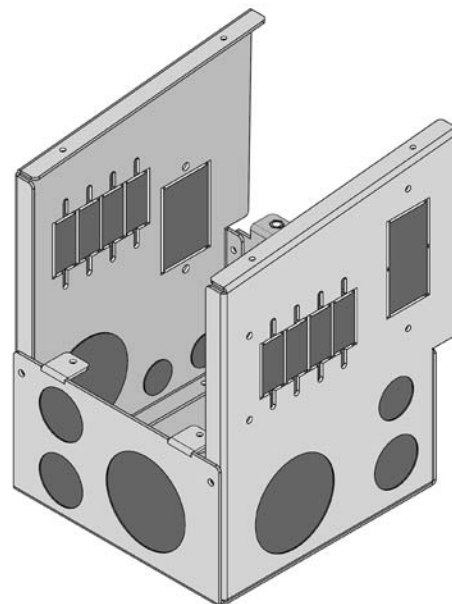

# FLEXware 250

**Model:** FW250

**Description:** DC and/or AC breaker enclosure for one FX Series Inverter/Charger

**Includes:** Ground bus bar, DC breaker handle guard, breaker mounting hardware and enclosure mounting hardware

Unit Dimensions (H x W x D)	Shipping Dimensions (H x W x L)	Shipping Weight	Enclosure Type
7.5 x 6.5 x 8.6" (19.1 x 16.5 x 21.8 cm)	9.75 x 8.4 x 11.6" (24.8 x 21.3 x 29.5 cm)	5 lbs. (2.3 kg)	Type-1 indoor (IP30)

Holds up to eight 1 to 80 Amp, one 175 or 250 Amp panel mount breaker and a GFCI AC outlet (not included).

- Does not use the DCA or ACA for connection to an FX Inverter/Charger.
- DC current shunt not included

## FLEXware 250 AC Input-Output-Bypass Assemblies

Field installable kit for bypassing the AC input to the AC output for inverter maintenance or installation. Also provides over-current protection.

**Model:** FW-IOB-S-120VAC

**Includes:** Three 60A 120VAC single pole PANEL mount breakers, sliding bypass interlock plate, wire and hardware kit

System Rating	Bypass Breaker	Input Breaker	Output Breaker
Single Phase 120VAC 60 Amp 7.2 kW	One Pole @ 60 Amps 7.2 kW	One Pole @ 60 Amps 7.2 kW	One Pole @ 60 Amps 7.2 kW

**Model:** FW-IOB-S-230VAC

**Includes:** Three 30A 120VAC single pole PANEL mount breakers, sliding bypass interlock plate, wire and hardware kit

System Rating	Bypass Breaker	Input Breaker	Output Breaker
Single Phase 230VAC 30 Amp 6.9 kW	One Pole @ 30 Amps 6.9 kW	One Pole @ 30 Amps 6.9 kW	One Pole @ 30 Amps 6.9 kW

# FLEXware 500



For applications with medium power requirements such as homes, light commercial or larger back-up power systems. The FLEXware 500 system architecture is capable of supporting up to two OutBack FX Series Inverter/Chargers, up to two MX60 Charge Controllers and all the associated AC and DC components. Thanks to a very compact design, FLEXware 500 AC and DC enclosures mount with a FLEXware MP in either a horizontal or vertical orientation to allow installation in more space limited locations for a fast and professional looking wall-mounted installation. The FLEXware 500 accommodates all of the essential protective devices in two enclosures.

## Breaker Configuration Diagram

### AC Side

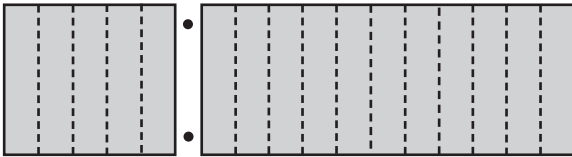

Holds up to sixteen DIN mount AC breakers (not included). Support for optional AC Input-Output-Bypass Assembly. AC breakers are rated from 10-16 Amps of AC current.

### DC Side

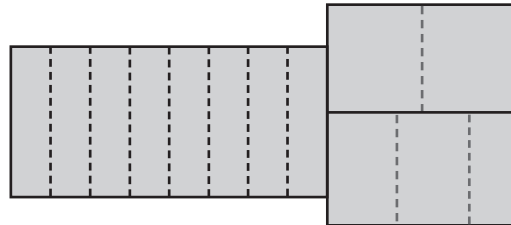

Holds up to eight small 0.75" (19 mm) wide, three medium 1" (26 mm) wide or two large 1.5" (32 mm) wide DC rated breakers. The small are rated for 1-80 Amps, medium for 100 or 125 Amps and the large are rated for 175 or 250 Amps of DC current.

## Knockout Location Diagram

### Back

- (2) 2" knockout (2.468" diameter)

### Left

- (5) 1" knockout (1.359" diameter)
- (2) 2" knockout (2.468" diameter)
- (2) Duplex GFCI Outlet knockout

### Right

- (9) 1" knockout (1.357" diameter)

### Top

- (3) 1" knockout (1.359" diameter)
- (1) 3/4" knockout (1.093" diameter)
- (4) 2" knockout (2.468" diameter)

### Bottom

- (3) 1" knockout (1.359" diameter)
- (1) 3/4" knockout (1.093" diameter)
- (4) 2" knockout (2.468" diameter)

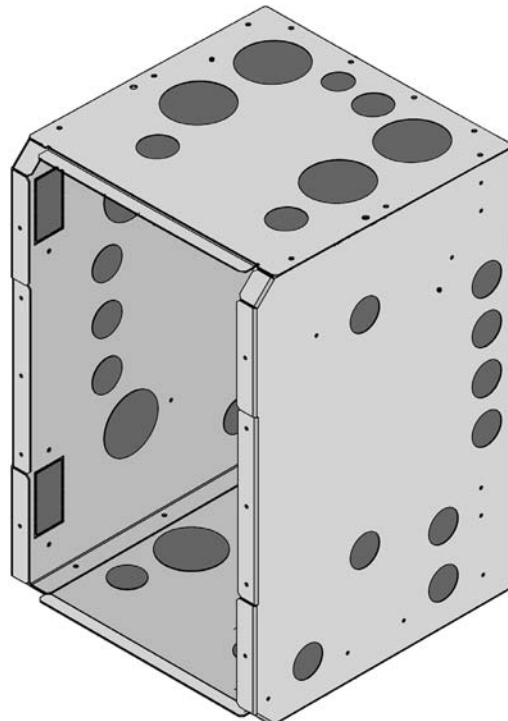

# FLEXware 500

## Model: FW500-DC

**Description:** DC enclosure which mounts at the DC side of one or two FX Series Inverter/Chargers. Supports six terminal bus bars (not including GBB) and three shunt assemblies.

**Includes:** Ground bus bar, 500 Amp DC shunt assembly, positive bus, breaker mounting hardware, FW-BBUS and enclosure mounting hardware

Unit Dimensions (H x W x D)	Shipping Dimensions (H x W x L)	Shipping Weight	Enclosure Type
18.2 x 11.4 x 12.1" (46.2 x 29 x 30.7 cm)	14.5 x 13.4 x 20.3" (36.8 x 34.1 x 51.6 cm)	15 lbs. (6.8 kg)	Type-1 indoor (IP30)

## Model: FW500-AC

**Description:** AC enclosure which mounts at the AC side of one or two FX Series Inverter/Chargers. Supports six terminal bus bars and one FW-X240.

**Includes:** Ground bus bar, DIN mounting bracket, communication cable conduit and enclosure mounting hardware

Unit Dimensions (H x W x D)	Shipping Dimensions (H x W x L)	Shipping Weight	Enclosure Type
18.2 x 11.4 x 12.1" (46.2 x 29 x 30.7 cm)	14.5 x 13.4 x 20.3" (36.8 x 34.1 x 51.6 cm)	15 lbs. (6.8 kg)	Type-1 indoor (IP30)

- The FW500 system utilizes one FW-MP mounting plate and a set of the DCA and ACA conduit adapters for each inverter/charger.
- DC and AC breakers, Input-Output-Bypass Assemblies and all other additional components sold separately.

# FLEXware 500 AC Input-Output-Bypass Assemblies

Field installable kit for bypassing the AC input to the AC output for inverter maintenance or installation. Also provides over-current protection.

## Model: FW-IOB-D-120/240VAC

**Includes:** Six 60A 120VAC single pole DIN mount breakers, sliding bypass interlock plate, wire and hardware kit

System Rating	Bypass Breaker	Input Breaker	Output Breaker
Split Phase 120/240 VAC 60 Amps 14.4 kW	Two Poles @ 60 Amps 14.4 kW	Two Poles @ 60 Amps 14.4 kW	Two Poles @ 60 Amps 14.4 kW

## Model: FW-IOB-D-120VAC

**Includes:** Six 60A 120VAC single pole DIN mount breakers, sliding bypass interlock plate, wire and hardware kit

System Rating	Bypass Breaker	Input Breaker	Output Breaker
Single Phase 120 VAC 120 Amps 14.4 kW	Two Poles @ 60 Amps 14.4 kW	Two Poles @ 60 Amps 14.4 kW	Two Poles @ 60 Amps 14.4 kW

## Model: FW-IOB-D-230VAC

**Includes:** Six 30A 230VAC single pole DIN mount breakers, sliding bypass interlock plate, wire and hardware kit

System Rating	Bypass Breaker	Input Breaker	Output Breaker
Single Phase 230 VAC 60 Amps 13.8 kW	Two Poles @ 30 Amps 13.8 kW	Two Poles @ 30 Amps 13.8 kW	Two Poles @ 30 Amps 13.8 kW

# FLEXware 1000



For applications with large power requirements such as large residential, commercial or village power systems. The FLEXware 1000 system architecture is capable of supporting up to four OutBack FX Series Inverter/Chargers, four MX60 Charge Controllers, and all the required AC and DC components and wiring. Utilizing a compact design, FLEXware 1000 AC and DC enclosures accommodate all of the essential protective devices with lots of room for additional breakers and large cable connections and can be mounted either vertically or horizontally.

## Breaker Configuration Diagram

### AC Side

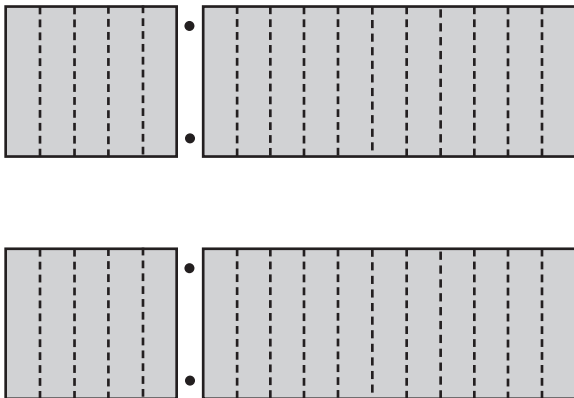

Holds up to thirty-two DIN mount AC breakers (not included). Support for optional AC Input-Output-Bypass Assembly. AC breakers are rated from 10-60 Amps of AC current.

### DC Side

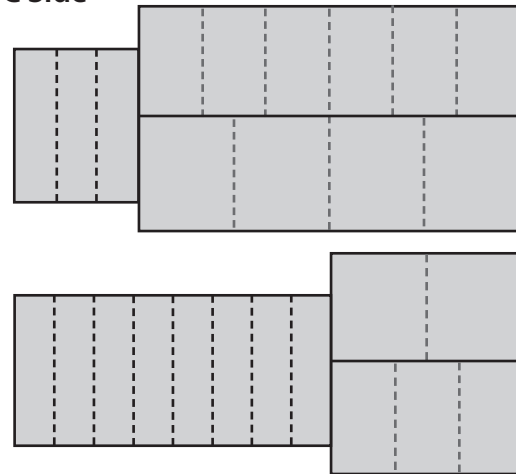

Holds up to eleven small 0.75" (19 mm) wide, nine medium 1" (26 mm) wide or six large 1.5" (32 mm) wide DC rated breakers. The small are rated for 1-80 Amps, the medium for 100 or 125 Amps and the large are rated for 175 or 250 Amps of DC current.

## Knockout Location Diagram

### Left

- (4) 2" knockout (2.468" diameter)
- (9) 1" knockout (1.359" diameter)
- (2) Duplex GFCI Outlet knockout

### Back

- (2) 2" knockout (2.468" diameter)
- (2) 1" knockout (1.359" diameter)

### Right

- (17) 1" knockout (1.359" diameter)

### Top

- (3) 1" knockout (1.359" diameter)
- (1) 3/4" knockout (1.093" diameter)
- (4) 2" knockout (2.468" diameter)

### Bottom

- (3) 1" knockout (1.359" diameter)
- (1) 3/4" knockout (1.093" diameter)
- (4) 2" knockout (2.468" diameter)

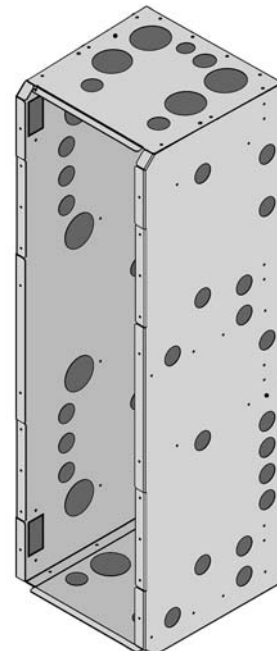



# FLEXware 1000

## Model: FW1000-DC

**Description:** DC enclosure which mounts at the DC side of three or four FX Inverter/Chargers. Supports eight terminal bus bars (not including GBB) and three shunt assemblies.

**Includes:** Ground bus bar, 1000 Amp DC, shunt assembly, positive bus, breaker mounting hardware, enclosure mounting hardware, two FW-SBUS and one FLEXware 1000 breaker bus

Unit Dimensions (H x W x D)	Shipping Dimensions (H x W x L)	Shipping Weight	Enclosure Type
38.5 x 11.4 x 12.1" (97.8 x 29.0 x 30.7 cm)	14.5 x 13.6 x 40.6" (36.8 x 34.5 x 103.1 cm)	21 lbs. (9.5 kg)	Type-1 indoor (IP30)

## Model: FW1000-AC

**Description:** AC enclosure which mounts at the AC side of three or four FX Inverter/Chargers. Supports eight terminal bus bars and one FW-X240.

**Includes:** Ground bus bar, two DIN mounting brackets and FLEXware 1000 wiring raceway

Unit Dimensions (H x W x D)	Shipping Dimensions (H x W x L)	Shipping Weight	Enclosure Type
38.5 x 11.4 x 12.1" (97.8 x 29.0 x 30.7 cm)	14.5 x 13.6 x 40.6" (36.8 x 34.5 x 103.1 cm)	21 lbs. (9.5 kg)	Type-1 indoor (IP30)

- The FW1000 system utilizes two FW-MP mounting plate and a set of the DCA and ACA conduit adapters for each inverter/charger.
- DC and AC breakers, Input-Output-Bypass Assemblies and all other additional components sold separately.

# FLEXware 1000 AC Input-Output-Bypass Assemblies

Field installable kit for bypassing the AC input to the AC output for inverter maintenance or installation. Also provides over-current protection.

## Model: FW-IOB-T-120/208VAC

**Includes:** Nine 60A 120VAC single pole DIN mount breakers, sliding bypass interlock plate, wire and hardware kit

System Rating	Bypass Breaker	Input Breaker	Output Breaker
Three Phase 120/208 VAC 60 Amps 21.6 kW	Three Poles @ 60 Amps 21.6 kW	Three Poles @ 60 Amps 21.6 kW	Three Poles @ 60 Amps 21.6 kW

## Model: FW-IOB-T-230/400VAC

**Includes:** Nine 30A 230VAC single pole DIN mount breakers, sliding bypass interlock plate, wire and hardware kit

System Rating	Bypass Breaker	Input Breaker	Output Breaker
Three Phase 230/400 VAC 30 Amps 20.7 kW	Three Poles @ 30 Amps 20.7 kW	Three Poles @ 30 Amps 20.7 kW	Three Poles @ 30 Amps 20.7 kW

## Model: FW-IOB-Q-120/240VAC

**Includes:** Twelve 60A 120VAC single pole DIN mount breakers, sliding bypass interlock plate, wire and hardware kit

System Rating	Bypass Breaker	Input Breaker	Output Breaker
Split Phase 120/240 VAC 120 Amps 28.8 kW	Four Poles @ 60 Amps 28.8 kW	Four Poles @ 60 Amps 28.8 kW	Four Poles @ 60 Amps 28.8 kW

## Model: FW-IOB-Q-120VAC

**Includes:** Twelve 60A 120VAC single pole DIN mount breakers, sliding bypass interlock plate, wire and hardware kit

System Rating	Bypass Breaker	Input Breaker	Output Breaker
Single Phase 120 VAC 240 Amps 28.8 kW	Four Poles @ 60 Amps 28.8 kW	Four Poles @ 60 Amps 28.8 kW	Four Poles @ 60 Amps 28.8 kW

## Model: FW-IOB-Q-230VAC

**Includes:** Twelve 30A 230VAC single pole DIN mount breakers, sliding bypass interlock plate, wire and hardware kit

System Rating	Bypass Breaker	Input Breaker	Output Breaker
Single Phase 230 VAC 120 Amps 27.6 kW	Four Poles @ 30 Amps 27.6 kW	Four Poles @ 30 Amps 27.6 kW	Four Poles @ 30 Amps 27.6 kW

# FLEXware MP

The FLEXware MP is a one piece, powder-coated aluminum mounting plate for FLEXware 500 and FLEXware 1000 enclosures. Utilizing stainless steel mounting hardware, the integrated locating bolts make installation quick and easy by providing guides to line up enclosures and inverter/chargers. A single FLEXware MP is designed to accommodate a FLEXware 500 while two FLEXware MPs are utilized in a FLEXware 1000 configuration.

Single MP Configuration for FLEXware 500

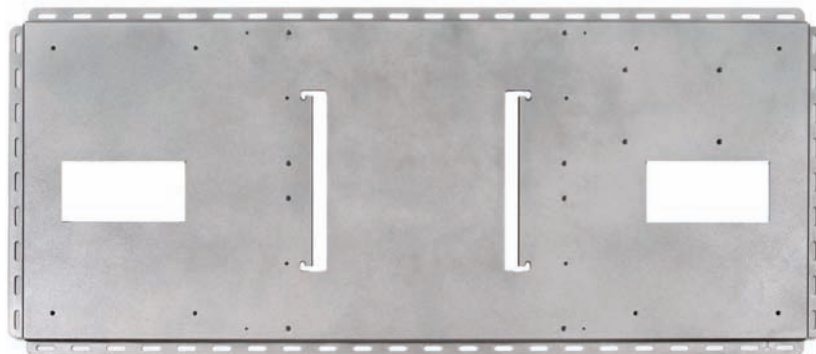

Dual MP Configuration for FLEXware 1000

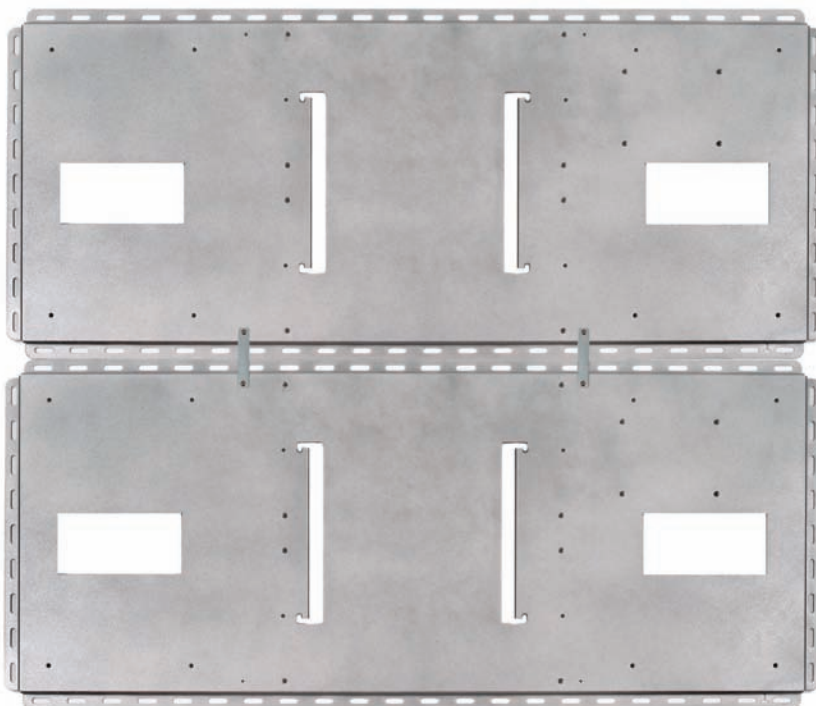

**Model:** FW-MP

**Description:** FLEXware system mounting plate

**Unit Dimensions (H x W x D)**

20.3 x 46.3 x .8" (51.6 x 117.6 x 2.1 cm)

**Shipping Dimensions (H x W x L)**

1.15 x 22.9 x 48.4" (2.9 x 58.2 x 123 cm)

**Shipping Weight**

14 lbs. (6.4 kg)

# Components

## OutBack DIN Mount Breakers

DIN rail mountable, hydraulic-magnetic type breakers that can be used for input, output or load circuits.



Model	Current Rating	Voltage Rating	Branch Circuit	Variation	Width
OBB-15-120VAC-DIN	15 Amp	120VAC 50/60Hz	10k AIC	Single pole	0.50" (13 mm)
OBB-15D-240VAC-DIN	15 Amp	120/240VAC 50/60Hz	10k AIC	Dual pole	1.0" (26 mm)
OBB-20-120VAC-DIN	20 Amp	120VAC 50/60Hz	10k AIC	Single pole	0.50" (13 mm)
OBB-20D-240VAC-DIN	20 Amp	120/240VAC 50/60Hz	10k AIC	Dual pole	1.0" (26 mm)
OBB-25D-240VAC-DIN	25 Amp	120/240VAC 50/60Hz	10k AIC	Dual pole	1.0" (26 mm)
OBB-10-277VAC-DIN	10 Amp	277VAC 50/60Hz	N/A	Single pole	0.5" (13 mm)
OBB-15-277VAC-DIN	15 Amp	277VAC 50/60Hz	N/A	Single pole	0.5" (13 mm)
OBB-30-277VAC-DIN	30 Amp	277VAC 50/60Hz	N/A	Single pole	0.5" (13 mm)
OBB-30D-480VAC-DIN	30 Amp	277/480VAC 50/60Hz	N/A	Dual pole	1.0" (26 mm)
OBB-30T-480VAC-DIN	30 Amp	277/480VAC 50/60Hz	N/A	Three pole	1.5" (39 mm)
OBB-50-277VAC-DIN	50 Amp	277VAC 50/60Hz	N/A	Single pole	0.5" (13 mm)
OBB-50D-480VAC-DIN	50 Amp	277/480VAC 50/60Hz	N/A	Dual pole	1.0" (26 mm)
OBB-50T-480VAC-DIN	50 Amp	277/480VAC 50/60Hz	N/A	Three pole	1.5" (39 mm)
OBB-60-277VAC-DIN	60 Amp	277VAC 50/60Hz	N/A	Single pole	0.5" (13 mm)

- #14 to 2 AWG clamp terminals

## OutBack Panel Mount Breakers

Panel mounted hydraulic-magnetic type breakers that can be used for DC sources, inverters or load circuits.



Model	Current Rating	Voltage Rating	Branch Circuit	Terminals	Width
OBB-1-125VDC120VAC-PNL	1 Amp	125VDC 120VAC	10k AIC	1/4" stud	0.75" (19 mm)
OBB-5-125VDC120VAC-PNL	5 Amp	125VDC 120VAC	10k AIC	1/4" stud	0.75" (19 mm)
OBB-10-125VDC120VAC-PNL	10 Amp	125VDC 120VAC	10k AIC	1/4" stud	0.75" (19 mm)
OBB-15-125VDC120VAC-PNL	15 Amp	125VDC 120VAC	10k AIC	1/4" stud	0.75" (19 mm)
OBB-20-125VDC120VAC-PNL	20 Amp	125VDC 120VAC	10k AIC	1/4" stud	0.75" (19 mm)
OBB-30-125VDC120VAC-PNL	30 Amp	125VDC 120VAC	10k AIC	1/4" stud	0.75" (19 mm)
OBB-40-125VDC120VAC-PNL	40 Amp	125VDC 120VAC	10k AIC	1/4" stud	0.75" (19 mm)
OBB-50-125VDC120VAC-PNL	50 Amp	125VDC 120VAC	10k AIC	1/4" stud	0.75" (19 mm)
OBB-60-125VDC120VAC-PNL	60 Amp	125VDC 120VAC	10k AIC	1/4" stud	0.75" (19 mm)
OBB-80-125VDC-PNL	80 Amp	125VDC	N/A	1/4" stud	0.75" (19 mm)
OBB-100-125VDC-PNL	100 Amp	125VDC	N/A	5/16" stud	1.0" (26 mm)
OBB-125-125VDC-PNL	125 Amp	125VDC	N/A	5/16" stud	1.0" (26 mm)
OBB-175-125VDC-PNL	175 Amp	125VDC	N/A	3/8" stud	1.5" (39 mm)
OBB-250-125VDC-PNL	250 Amp	125VDC	N/A	3/8" stud	1.5" (39 mm)

- ETL Listed for 150 VDC max open circuit. For PSPV applications only.

# Components

## OutBack PV Ground Fault Protection System

Ground fault protection is required by the NEC for PV arrays mounted on or within a specified vicinity of residential dwelling roofs as a safety precaution. The OutBack PV Ground Fault Protection System protects wiring and system components for one or two PV arrays when used in a FLEXware 250, FLEXware 500 or FLEXware 1000.



Model	Description	Terminals	Width
OBB-GFP-80D-125VDC-PNL	OutBack PV Ground Fault Protection 80 Amp 125VDC dual pole panel mount	1/4" stud	2.25" (57 mm)

Uses three 3/4" wide panel mount breaker spaces

## X-240 Auto-transformer

Designed to be housed within the FLEXware 500 or FLEXware 1000 AC enclosures. The FW-X240 auto transformer with a 120 volt/30 Amp primary and secondary winding can be used for step-up, step-down, generator and split phase output balancing for series stacked inverters. It can transfer 2kW from one 120 VAC leg of a generator or the total rating of an OutBack stacked series/parallel 120/240 VAC inverter/charger configuration.



Model	Description	Includes
FW-X240	Auto-transformer 4 kVA 120/240VAC 60Hz with 25 Amp dual pole breaker for mounting inside of FLEXware 500-AC or FLEXware 1000-AC	Auto-transformer , 25 Amp dual pole breaker and mounting hardware

## DC Bus Bars

OutBack Power Systems DC bus bars are designed to enable the most complex of code compliant DC cable connections.



Model	Description	Includes
FW-BBUS	Breaker Bus allows connection of two 175-250 Amp, three 100-125 Amp, four 1-80 Amp DC breakers or three 500 Amp DC current shunts	Plated copper plate rated for 500 Amps
FW-CBUS	Combiner Bus connects up to eight DIN mounted breakers or four DIN mounted fuse holders	One 1/0 AWG set screw lug - plated copper rated for 200 Amps
FW-SBUS	Shunt Bus allows up to four high current cable connections on same side of DC shunt	Two 3/8 inch bolts solid brass rated for 1000 Amps

## DC Current Shunts

When used with an amp hour meter OutBack Power Systems DC current shunt kits can provide valuable insight into the status of your batteries or DC power source. One shunt kit is included standard on FLEXware 500 and FLEXware 1000 DC enclosures.



Model	Description	Includes
FW-SHUNT250	500 Amp DC current shunt with attached terminal bus bar for mounting on top of a FX Series Inverter/Charger	Shunt, mounting hardware and terminal bus bar for connection to FX Inverter's DC negative terminal
FW-SHUNT500	500 Amp DC current shunt with attached terminal bus bar	Shunt, terminal bus bar and one white insulator and mounting screws



# Components

## Conduit Adapters

Allows connection of the FX and VFX Inverter/Chargers to FLEXware 500 and FLEXware 1000 enclosures, one ACA and DCA required per FX Inverter/Charger.

Model	Description	Includes
ACA	Adapter for AC end of FX Inverter/Charger	ACA, bushing and mounting hardware
DCA	Adapter for DC end of FX Inverter/Charger	DCA, bushing and mounting hardware

## Charge Controller Mounting Brackets

FW-CCB and FW-CCB2 mounting brackets allow OutBack Power Systems charge controllers to be mounted on the side of FW500-DC or FW1000-DC enclosures. FW-CCB2-T mounting bracket allows OutBack Power Systems charge controllers to be mounted on the top of FW500-DC or FW1000-DC enclosures.



Model	Description	Includes
FW-CCB	Bracket for mounting a single MX60 Charge Controller	Bracket, bushings and mounting hardware
FW-CCB2	Bracket for mounting two MX60 Charge Controllers	Brackets, bushings and mounting hardware
FW-CCB2-T	Bracket for mounting two MX60 Charge Controllers	Bracket, bushings and mounting hardware

## DC Cable Assemblies

DC interconnect cable assemblies for wiring between inverter/chargers and breakers or DC shunts. Can also be used as battery interconnects. The THW type cable assemblies are UL listed and NEC compliant with a maximum voltage rating of 1000VDC and a temperature rating of 105°C.

Model	Description	Hole to hole length
FW-CABLE250-15R	250 Amp 4/0 AWG DC cable 15 inches (380 mm) long with ring terminals on both ends and red heat shrink. For connection from 250 Amp DC breaker to inverter positive terminal.	19" (483mm)
FW-CABLE175-15R	175 Amp 2/0 AWG DC cable 15 inches (380 mm) long with ring terminals on both ends and red heat shrink. For connection from 175 Amp DC breaker to inverter positive terminal.	19" (483 mm)
FW-CABLE250-36R	250 Amp 4/0 AWG DC cable 36 inches (915 mm) long with ring terminals on both ends and red heat shrink. For connection from 250 Amp DC breaker to inverter positive terminal.	40" (1016 mm)
FW-CABLE175-36R	175 Amp 2/0 AWG DC cable 36 inches (915 mm) long with ring terminals on both ends and red heat shrink. For connection from 175 Amp DC breaker to inverter positive terminal.	40" (1016 mm)
FW-CABLE250-36W	250 Amp 4/0 AWG DC cable 36 inches (915 mm) long with ring terminals on both ends and white heat shrink. For connection from DC current shunt to inverter negative terminal.	40" (1016 mm)
FW-CABLE175-36W	175 Amp 2/0 AWG DC cable 36 inches (915 mm) long with ring terminals on both ends and white heat shrink. For connection from DC current shunt to inverter negative terminal.	40" (1016 mm)

- All ring lugs have 3/8" (9.53 mm) diameter hole.

# PSPV

The rainproof PSPV is a solar array combiner which can be used with a wide variety of system configurations and solar module types. Approved for installation on both vertical and angled surfaces with a slope as little as 3-in-12 pitch - or pole mounted (brackets not included), the PSPV is designed to provide NEC code compliant series over-current protection of the wiring of multiple PV modules or sub arrays for connection to charge controllers, inverters or other system components. The PSPV is easily field configurable to match your PV system design and amperage requirements. For negative or positive grounded PV systems.



## Breaker Configuration Diagram

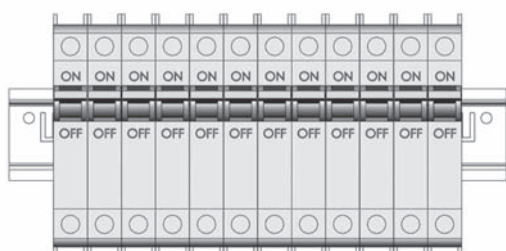

## Fuse Configuration Diagram

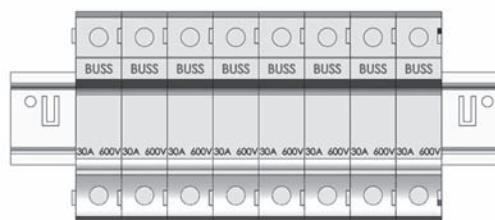

Holds up to twelve OutBack Power Systems DIN mounted breakers for PV array configurations of 12 to 72 VDC systems with a maximum open circuit voltage of 150 VDC or use eight OutBack Power Systems OBF "touch safe" type fuse holders for high voltage systems with a maximum open circuit voltage of 600 VDC

## Knockouts

### Left

- (1) 3/4" knockout (0.875" diameter)

### Right

- (1) 3/4" knockout (0.875" diameter)

### Back

- (1) combination 1" (1.093" diameter)  
1 3/8" (1.375" diameter) knockout

### Bottom

- (1) combination 1" (1.093" diameter),  
1 3/8" (1.375" diameter) knockout
- (8) 3/4" knockout (0.875" diameter)

**Model:** PSPV

**Description:** Powder coated aluminum PV array combiner box

**Includes:** Enclosure, dual combining bus bars, one terminal bus bar, two #1/0 AWG set-screw compression type box lug terminals and one #1/0 AWG ground lug

Unit Dimensions (H x W x D)

13.1 x 8.8 x 3.4" (34.1 x 22.4 x 8.6 cm)

Shipping Dimensions (H x W x L)

16 x 12 x 7" (40.6 x 30.5 x 17.8 cm)

Shipping Weight

5 lbs (2.3 kg)

Enclosure Rating

Type 3R (IP44)

# PSPV

## OutBack DC DIN Mount Breakers

DIN rail mount breakers are hydraulic-magnetic type and are not affected by high ambient temperatures.

Model	Current Rating	Voltage Rating*	Terminals	Width
OBB-1-125VDC-DIN	1 Amp	125VDC	#14 to 2 AWG clamp terminals	0.5" (13 mm)
OBB-2-125VDC-DIN	2 Amp	125VDC	#14 to 2 AWG clamp terminals	0.5" (13 mm)
OBB-3-125VDC-DIN	3 Amp	125VDC	#14 to 2 AWG clamp terminals	0.5" (13 mm)
OBB-4-125VDC-DIN	4 Amp	125VDC	#14 to 2 AWG clamp terminals	0.5" (13 mm)
OBB-5-125VDC-DIN	5 Amp	125VDC	#14 to 2 AWG clamp terminals	0.5" (13 mm)
OBB-6-125VDC-DIN	6 Amp	125VDC	#14 to 2 AWG clamp terminals	0.5" (13 mm)
OBB-8-125VDC-DIN	8 Amp	125VDC	#14 to 2 AWG clamp terminals	0.5" (13 mm)
OBB-9-125VDC-DIN	9 Amp	125VDC	#14 to 2 AWG clamp terminals	0.5" (13 mm)
OBB-10-125VDC-DIN	10 Amp	125VDC	#14 to 2 AWG clamp terminals	0.5" (13 mm)
OBB-15-125VDC-DIN	15 Amp	125VDC	#14 to 2 AWG clamp terminals	0.5" (13 mm)
OBB-20-125VDC-DIN	20 Amp	125VDC	#14 to 2 AWG clamp terminals	0.5" (13 mm)
OBB-30-125VDC-DIN	30 Amp	125VDC	#14 to 2 AWG clamp terminals	0.5" (13 mm)
OBB-50-125VDC-DIN	50 Amp	125VDC	#14 to 2 AWG clamp terminals	0.5" (13 mm)
OBB-60-125VDC-DIN	60 Amp	125VDC	#14 to 2 AWG clamp terminals	0.5" (13 mm)

\* Approved for maximum VOC of 150 VDC by ETL for PV array applications only.

## OutBack High Voltage DIN Mount Fuse Holders and Fuses

Fuse holders are DIN rail mount with #8 AWG set-screw type compression terminals. Touch-safe design and not rated for load make or load break usage. Maximum of eight fuseholders in one PSPV enclosure.

Model	Description	Current Rating	Voltage Rating	Width
OBF-6-600VDC	Fuse	6 Amp	600VDC	N/A
OBF-10-600VDC	Fuse	10 Amp	600VDC	N/A
OBF-15-600VDC	Fuse	15 Amp	600VDC	N/A
OBFH-30-600VDC-DIN	Fuse Holder	30 Amp	600VDC	0.7" (18 mm)

## Terminal Bus Bars

Used for adding more wire terminations or for isolating multiple positive/negative circuits. All TBB models have three #1/0 to 14 AWG and eight #6 to 14 AWG screw type compression terminals, which means no ring lugs are required. Available with black, white, red, blue and brown insulators. All required TBBs are included with the AC Input-Output-Bypass Assemblies.

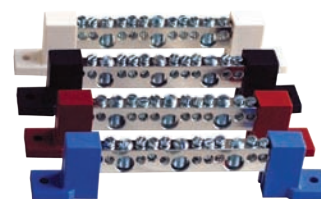

Model	Description	Terminals
TBB-GROUND	Ground/Neutral terminal bus bar with mounting screws (no insulators)	Three #1/0 to 14 AWG and Eight #6 to 14 AWG screw type compression
TBB-BLACK	Bus bar with black insulators with mounting screws - use as L1 hot or DC negative	Three #1/0 to 14 AWG and Eight #6 to 14 AWG screw type compression terminals
TBB-BLUE	Bus bar with blue insulators with mounting screws - use as Phase C on three phase systems	Three #1/0 to 14 AWG and Eight #6 to 14 AWG screw type compression terminals
TBB-RED	Bus bar with red insulators with mounting screws - use as L2 hot or DC positive	Three #1/0 to 14 AWG and Eight #6 to 14 AWG screw type compression terminals
TBB-WHITE	Bus bar with white insulators with mounting screws - use as AC neutral or DC negative	Three #1/0 to 14 AWG and Eight #6 to 14 AWG screw type compression terminals
TBB-BROWN	Bus bar with brown insulators with mounting screws - use as AC hot in European systems	Three #1/0 to 14 AWG and Eight #6 to 14 AWG screw type compression terminals



**Corporate Headquarters**  
19009 62nd Avenue NE  
Arlington, WA 98223 USA  
Phone: (360) 435.6030  
Fax: (360) 435.6019

**European Office**  
Barcelona, ESPAÑA  
Phone: (+34) 600.843.845

[www.outbackpower.com](http://www.outbackpower.com)

980-0002-01-00 REV B